



GreenSquare – Stands out above the rest



Table of contents

GreenSquare – Stands out above the rest	Page 3
Frequently Asked Questions & Answers	Page 4
Wall Frames – Portrait	Page 5 – 22
Wall Frames – Landscape	Page 23 – 32
Directory	Page 33 – 40
Suspended Signs	Pages 41 – 52
Flag Signs	Pages 53 – 56
Corner Signs	Pages 57 – 64
Table Signs	Pages 65 – 68
Bookmarks & Sample Kits	Page 69

Legend - Graphic implementation

- ① Paper graphics with polycarbonate cover of 0.5mm width
- ② Vinyl on polycarbonate cover of 0.5mm width
- ③ Paper graphics with polycarbonate cover of 1mm width
- ④ Vinyl on polycarbonate cover of 1mm width
- ⑤ Paper graphics with polycarbonate cover of 2mm width
- ⑥ Vinyl on polycarbonate cover of 2 mm width with reinforcement tape
- ⑦ Paper graphics with perspex cover (cast) of 3mm width
- ⑧ Vinyl/print on Xbond board of 2mm width
- ⑨ Vinyl/print on aluminum board of 0.5mm width
- ⑩ Vinyl/print on aluminum board of 0.8mm width

For each sign in the catalog you'll find our recommendation regarding the appropriate graphic implementation. Please consult the Legend.

FLAT MODULAR SIGN SYSTEM



GreenSquare was founded in 2010 with a definitive mission to offer the international sign industry a leading Flat Modular Sign System that is both elegantly designed and technologically advanced.

GreenSquare offers a variety of flat signage solutions designed to match and complement any project. From standard frames to elegant design solutions, we offer it all, including the leading "GreenSquare Float" design which is our crown jewel.

The GreenSquare system is based on flat sign frames that accept a spectrum of inserts materials of different thicknesses due to our "Smart Insert" technology. Our products are extremely modular and can be tweaked and designed to match any need. Custom made solutions can be easily fabricated utilizing the flexibility of the system.

GreenSquare Company policy:

- We offer flat modular sign solutions, nothing else!
- We offer ever-improving customer service.
- Swift delivery times, based on our Global Shipping Network.
- We will match any price.
- We only sell to sign professionals.
- We offer 100% Satisfaction Guaranty.
- We strive for design leadership, as we continuously develop new and exciting products, utilizing state of the art technology and materials.
- **We don't say No, we just try harder!**

Frequently Asked Questions & Answers

Q: What types of flat signs are available in the GreenSquare system?

A: Wall signs (standard, floating, floating corner, directory), table Signs, suspended signs and flag signs.

Q: Is GreenSquare an indoor or outdoor sign system?

A: The system is mainly for indoor use, but supports a variety of outdoor solutions.

Q: What sizes are supported by GreenSquare?

A: The system supports a great variety of sizes leading up to 100cm X 100cm / 40".

Q: Does GreenSquare support using firm inserts?

A: Yes, the system supports firm inserts thanks to a special cover extrusion.

Q: Does GreenSquare support Braille components for the visually impaired?

A: Yes.

Q: In which colors is the system offered?

A: The aluminum parts of the system are available in 3 finishes, aluminum, black and gold.

Q: What insert width range does the GreenSquare system support?

A: The system supports insert widths of up to 3mm / 0.12", thanks to a special cover extrusion.

Q: Is GreenSquare a modular signage system?

A: Yes.

Q: What is the technological aspect of GreenSquare's floating effect (the signs appear as floating in front of the wall)?

A: The system features a special floating profile that is attached to the sign frame to create the floating effect.

Q: How do I update the system's inserts when an update is required?

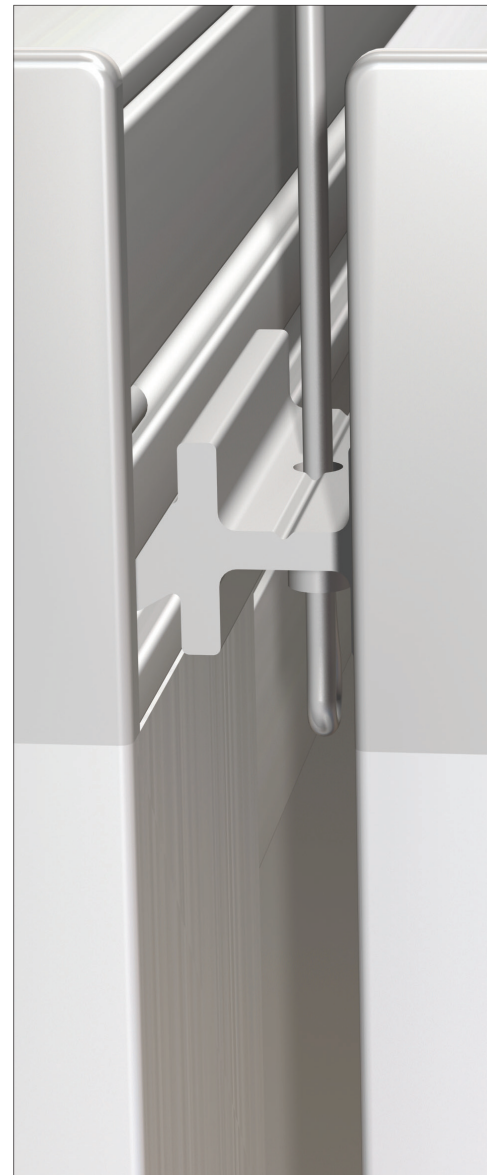
A: There are two ways to update the inserts: First, if the insert is flexible you can simply apply a suction cup to pull it out. Second, in case the insert is not flexible, you simply disconnect one of the special cover extrusions mechanically fastened to the frame.

Q: Is it possible to order signs of non catalog sizes?

A: Yes, GreenSquare is a modular signage system that supports non catalog sizes.

Q: Is it possible to order signs of other than the standard colors?

A: Yes, custom finishes are optional.

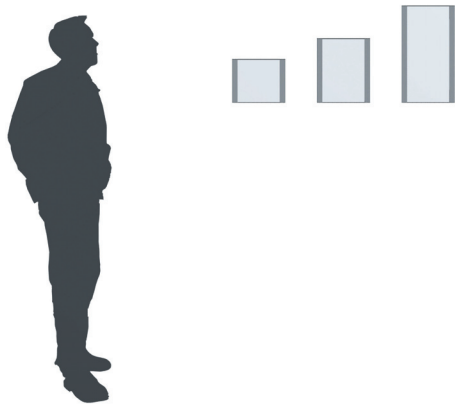


FLAT MODULAR SIGN SYSTEM



The GreenSquare portrait wall frames (also available in an eye catching floating design) are a perfect choice for room identification signs, bathroom signs and general way-finding signs. The portrait position is determined by the position of the end caps on the bottom and top of the sign frame.

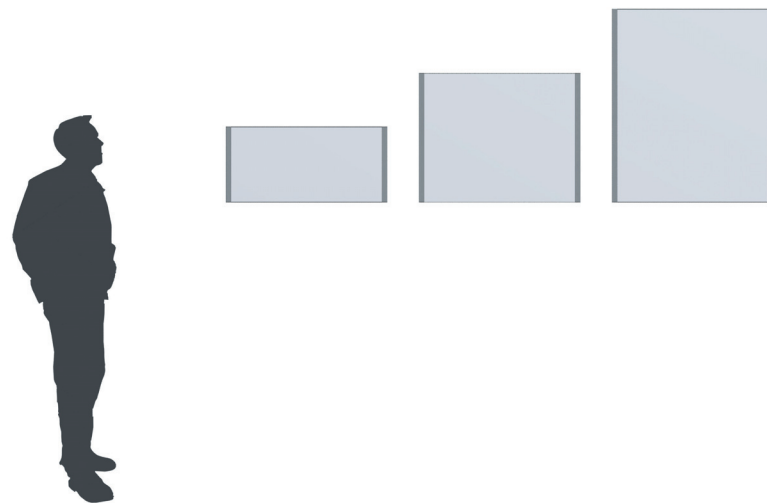
WFF-A4-P

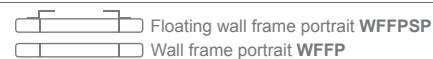


WFF-400-P

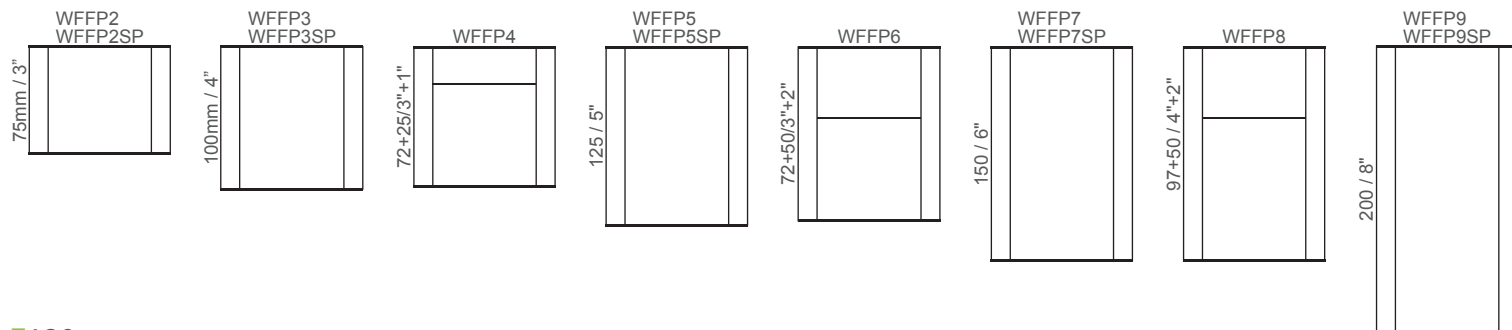


WFF-700-P

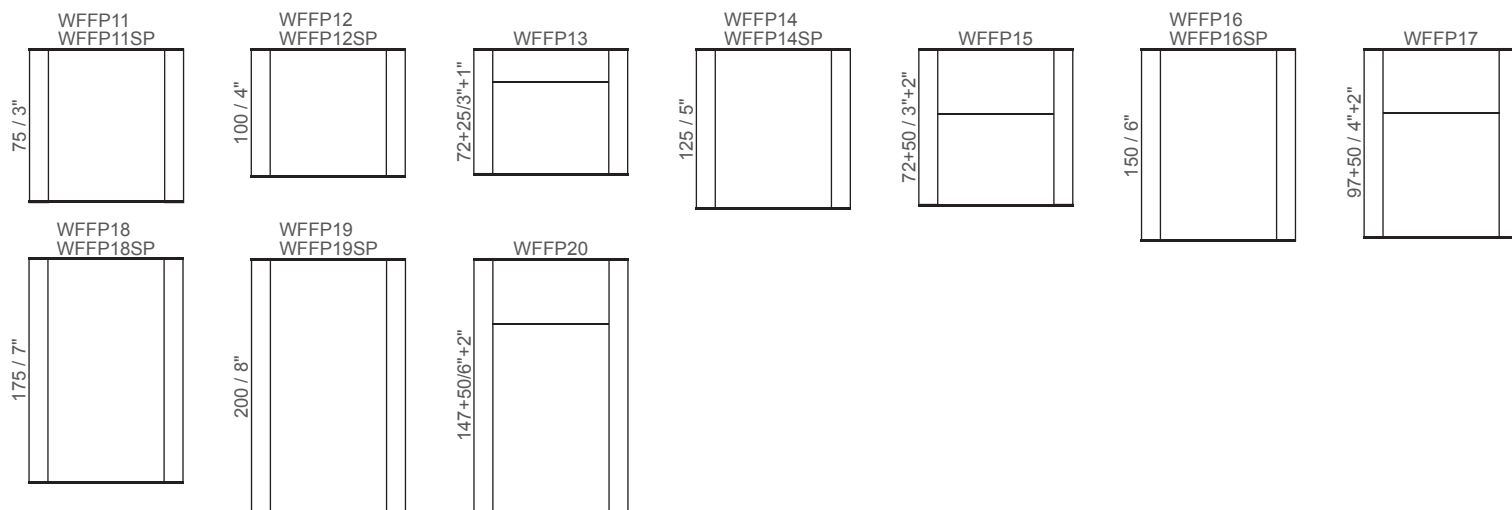




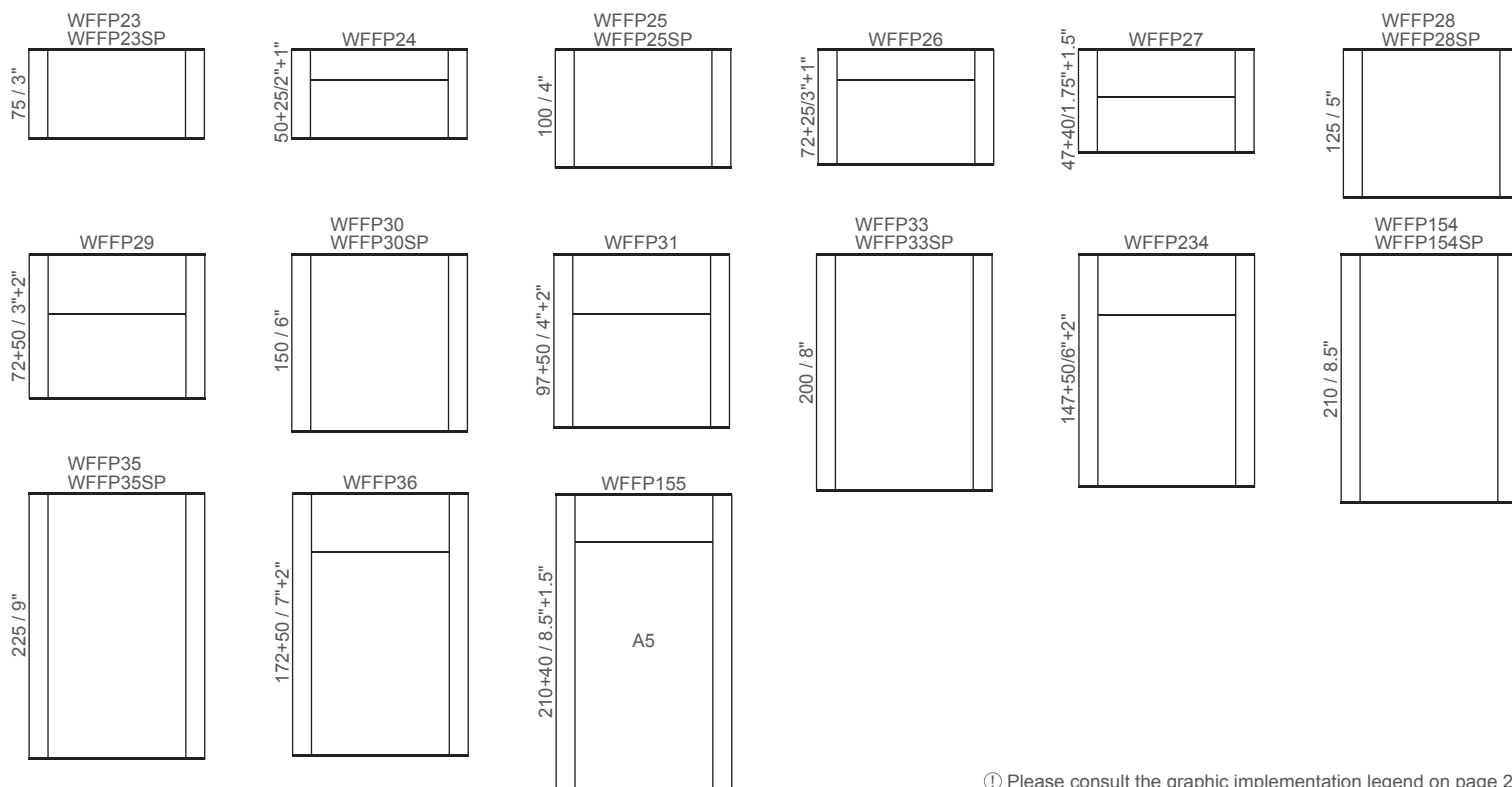
F100 ①②⑧⑨



F120 ③④⑧⑨


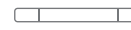


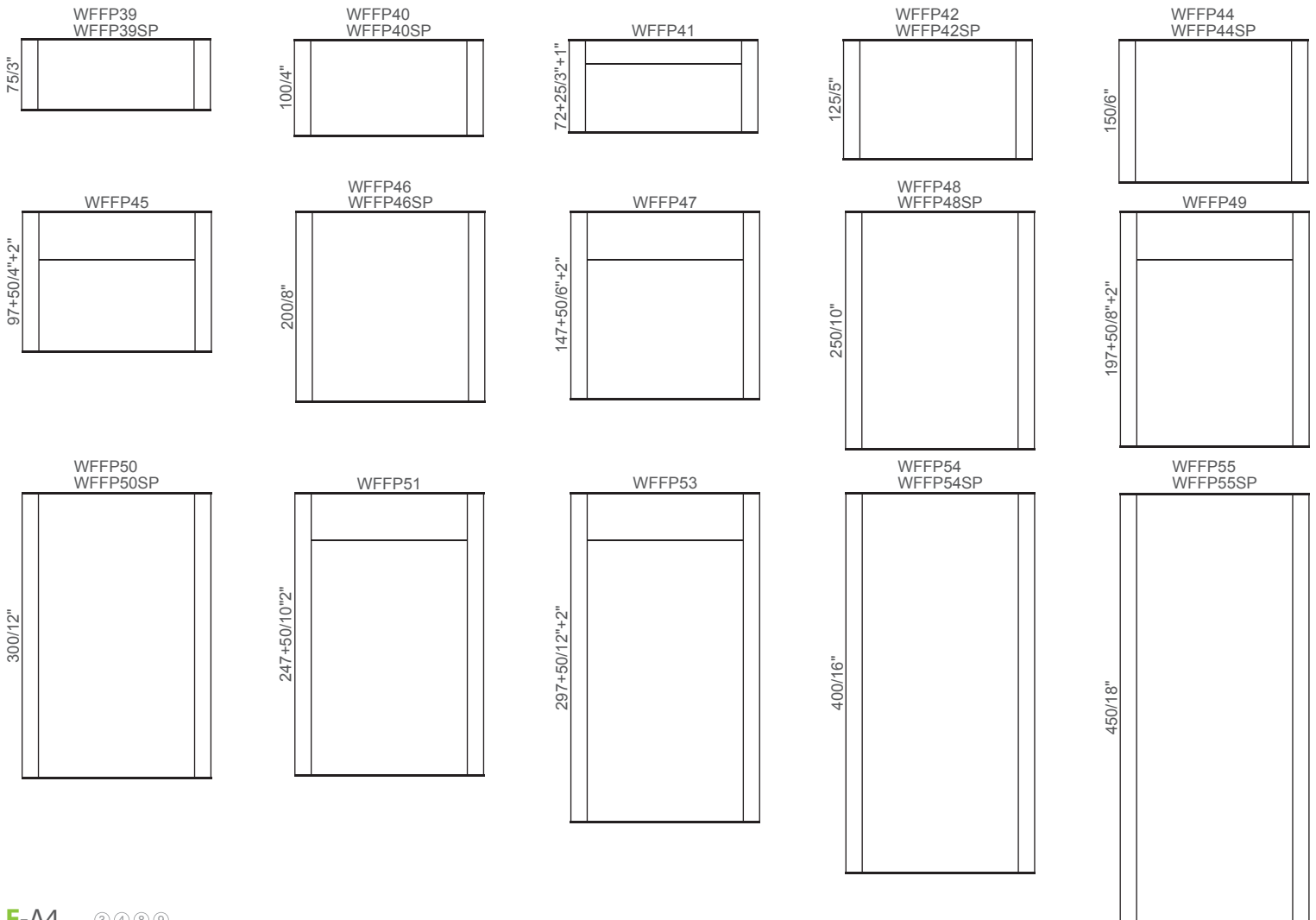
F150 ③④⑧⑨



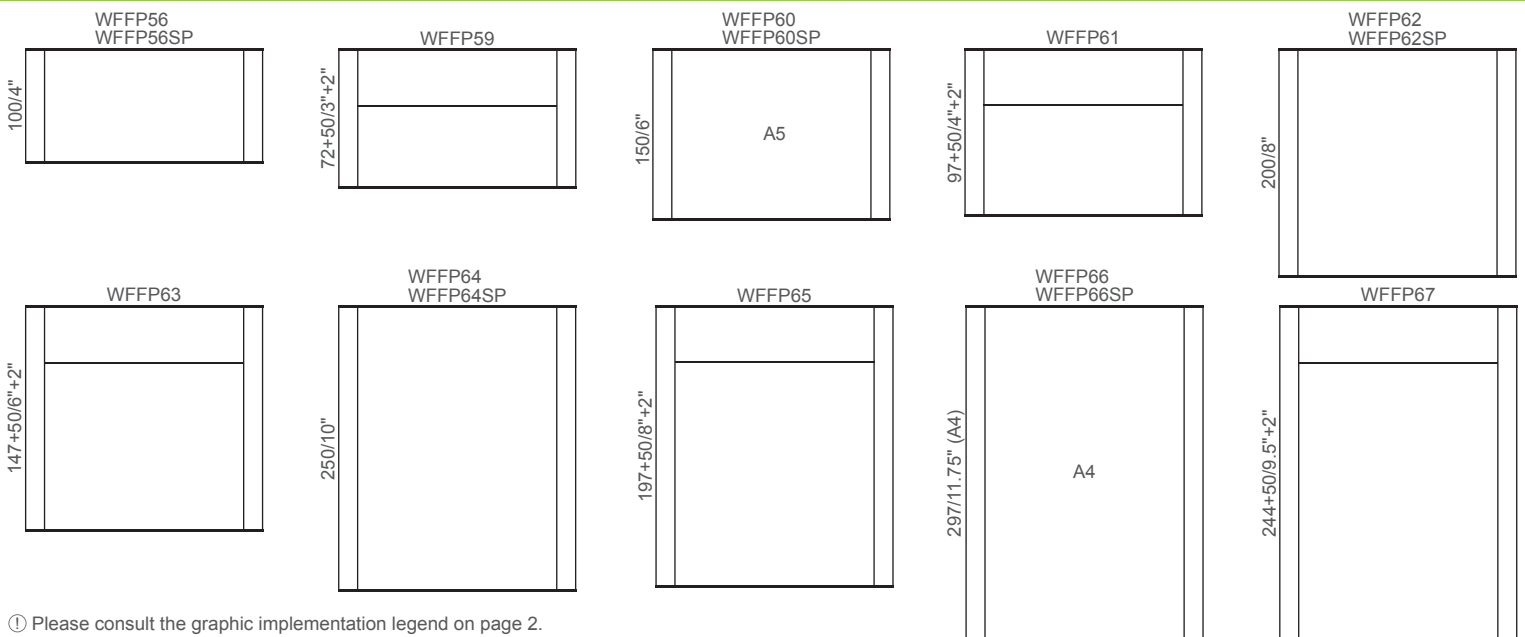
① Please consult the graphic implementation legend on page 2.

F200 ③④⑧⑨

 Floating wall frame portrait **WFFPSP**
 Wall frame portrait **WFFP**




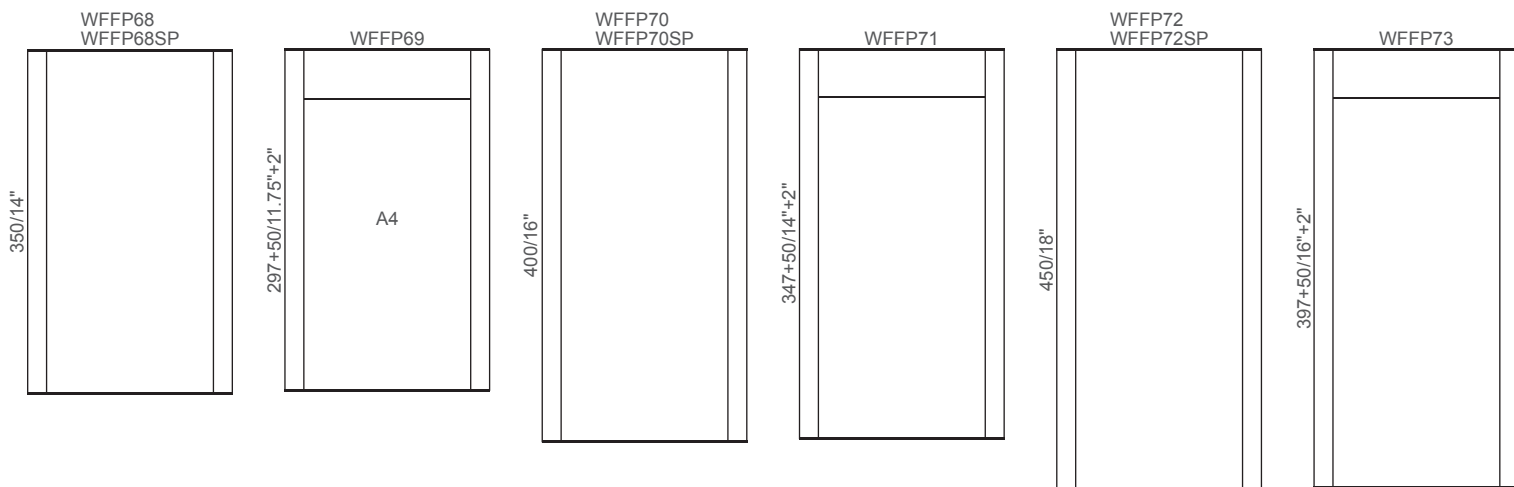
F-A4 ③④⑧⑨



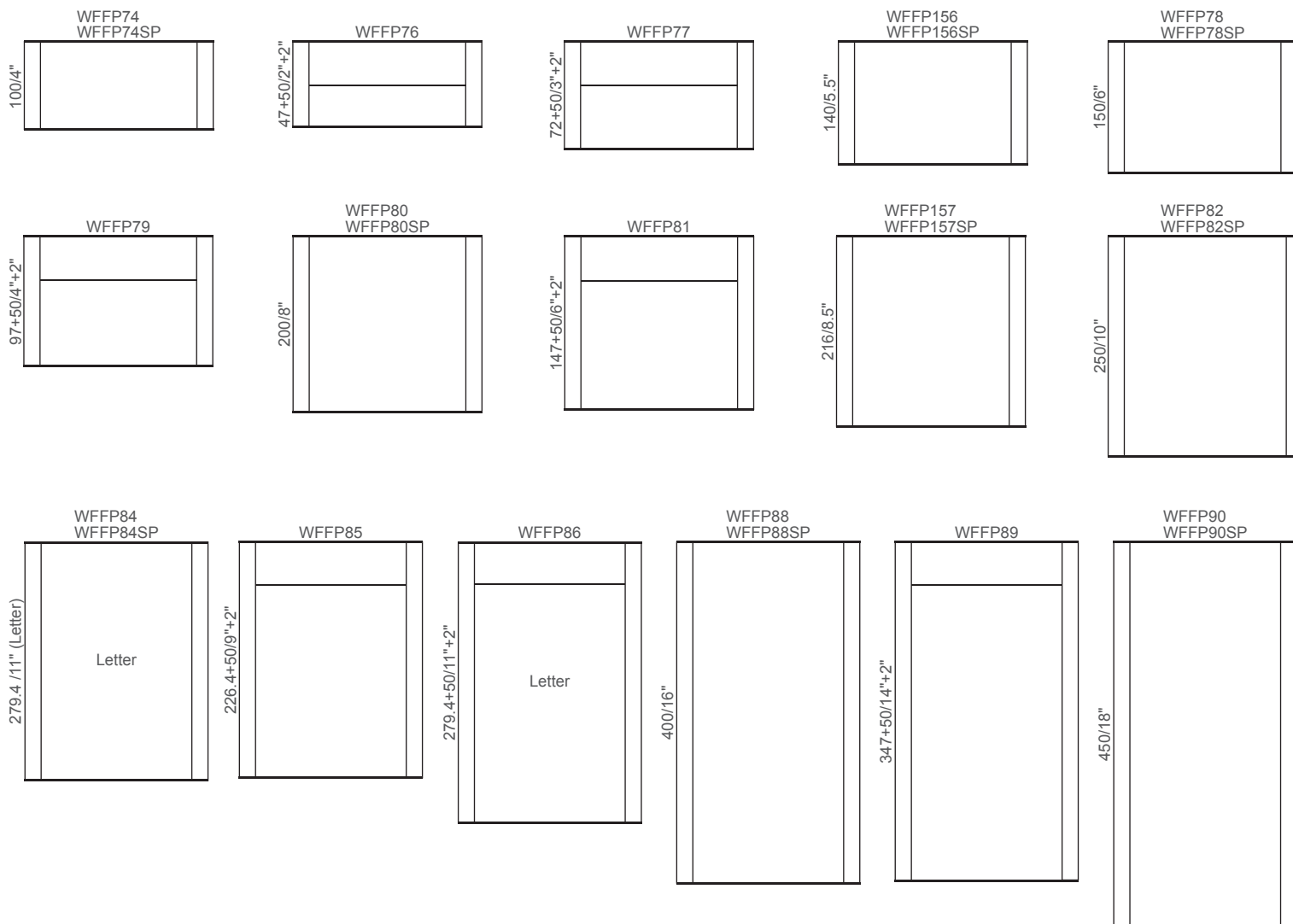
ⓘ Please consult the graphic implementation legend on page 2.

F-A4 ③④⑧⑨

 Floating wall frame portrait **WFFPSP**
 Wall frame portrait **WFFP**




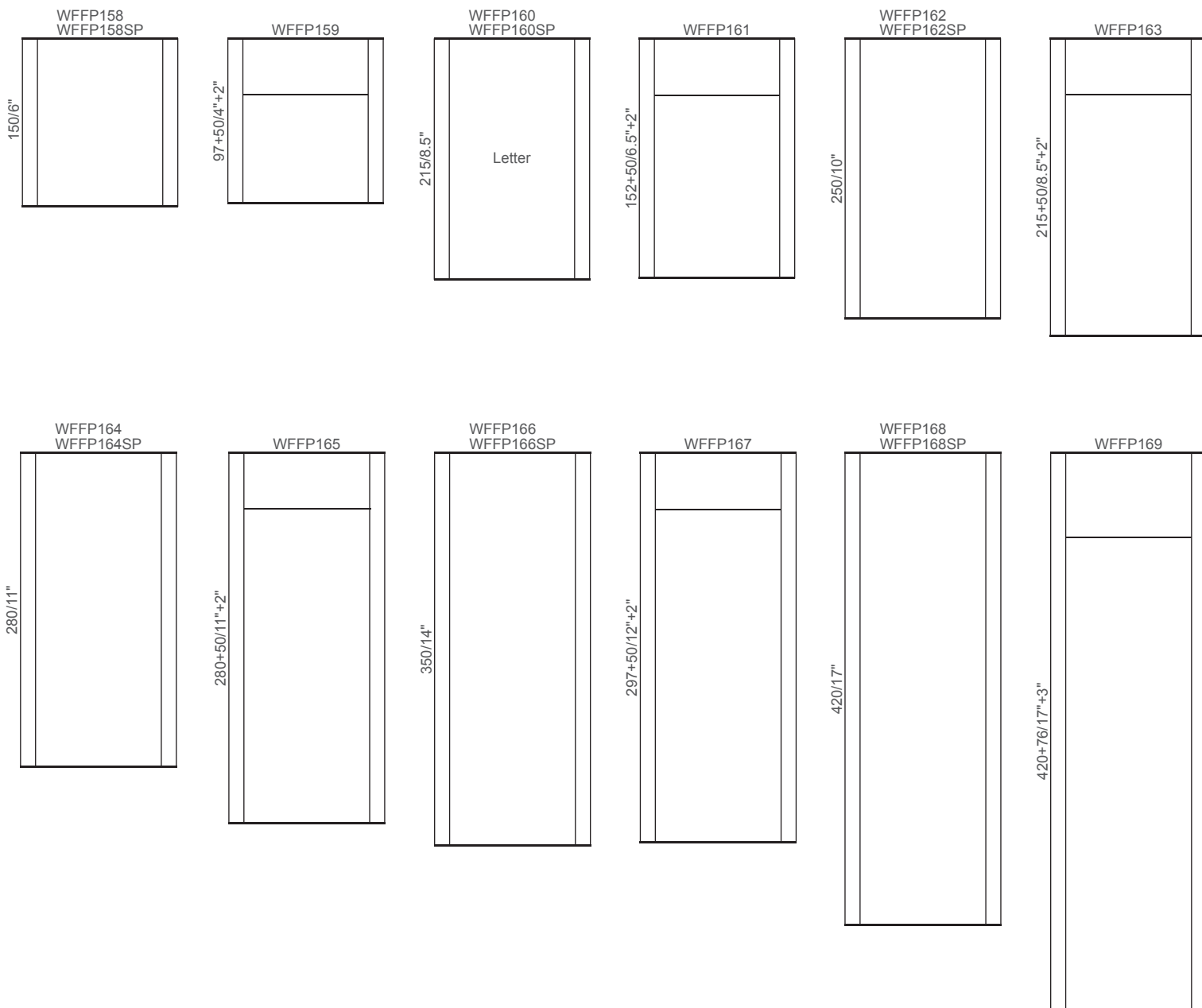
F-Letter ③④⑧⑨



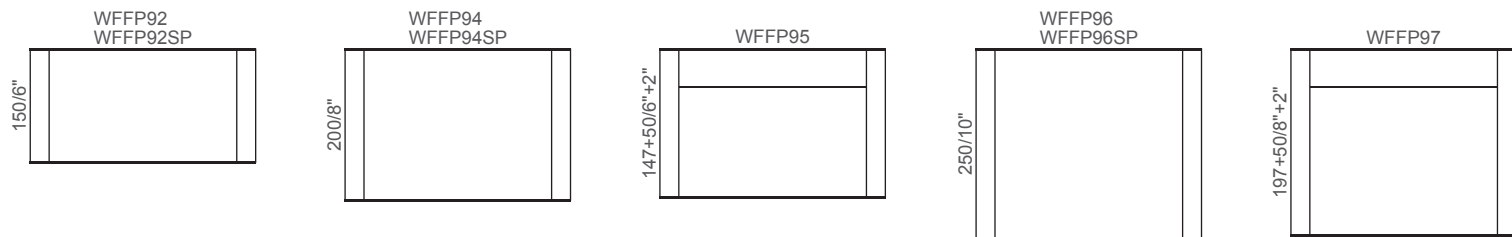
① Please consult the graphic implementation legend on page 2.

F11 ③④⑧⑨

 Floating wall frame portrait **WFFPSP**
 Wall frame portrait **WFFP**





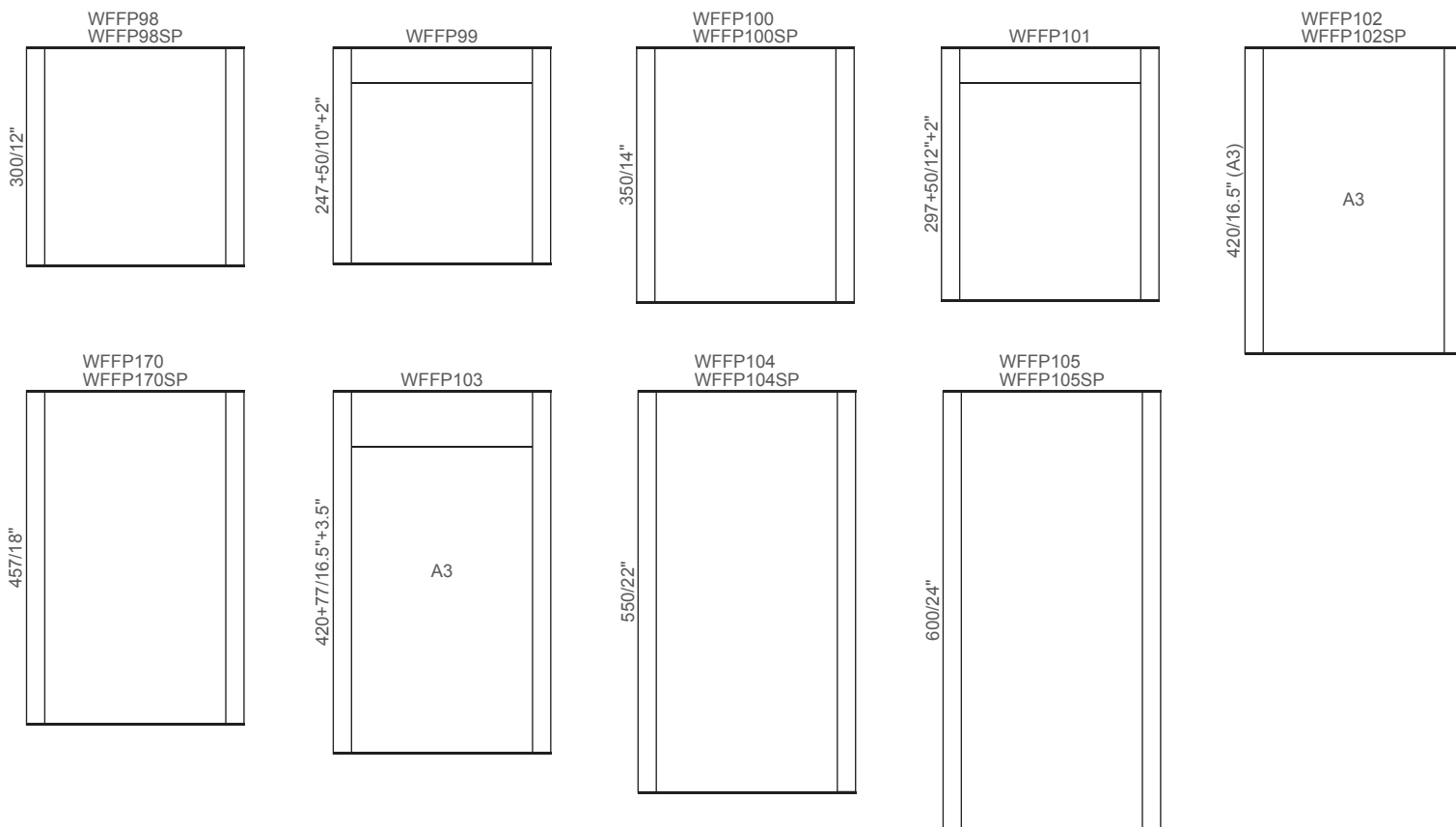
F300 ③④⑧⑨



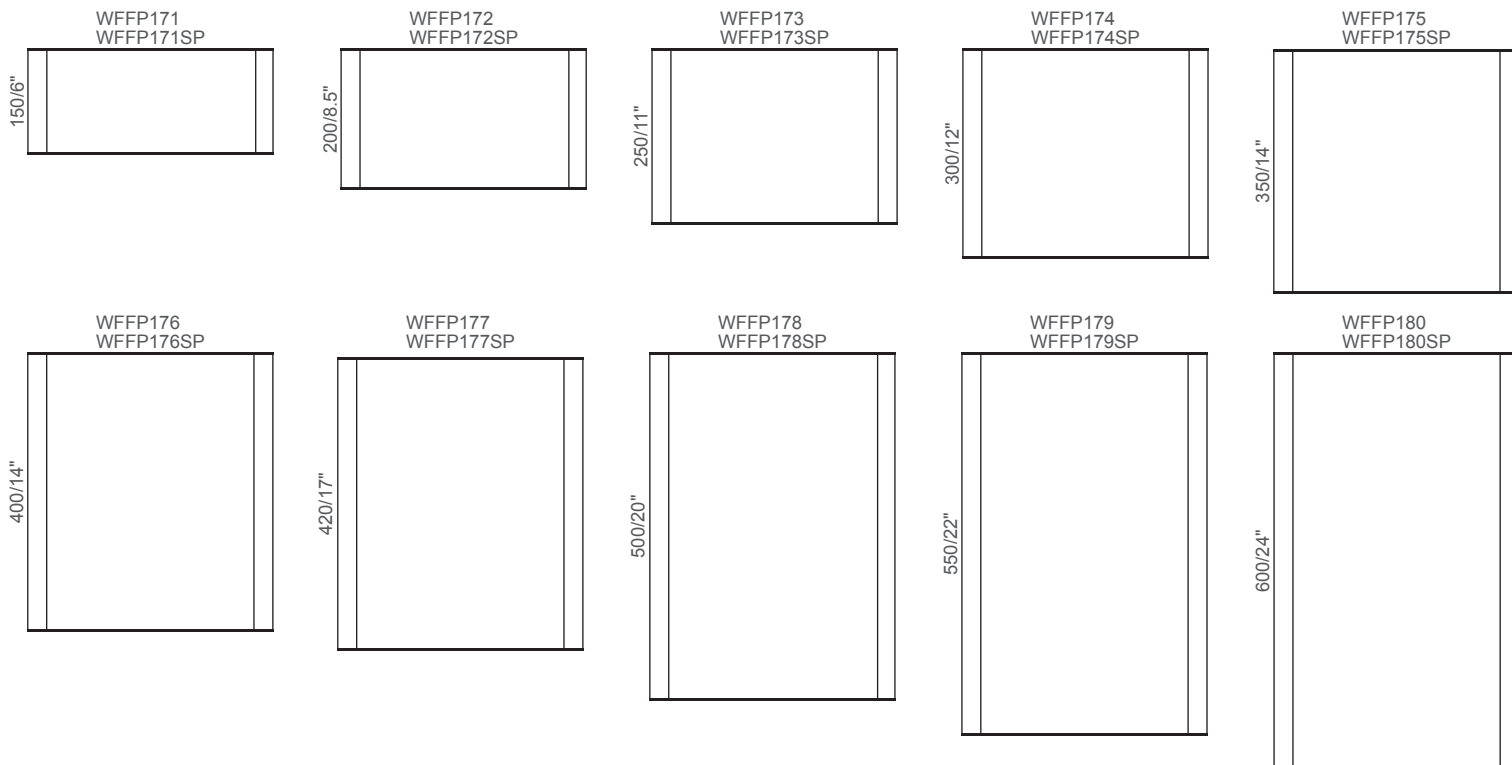
① Please consult the graphic implementation legend on page 2.

F300 ③④⑧⑨

 Floating wall frame portrait **WFFPSP**
 Wall frame portrait **WFFP**





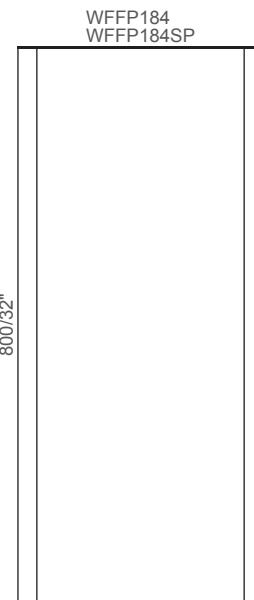
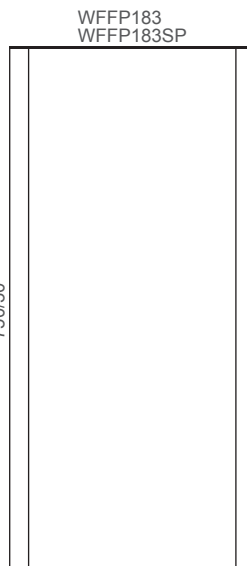
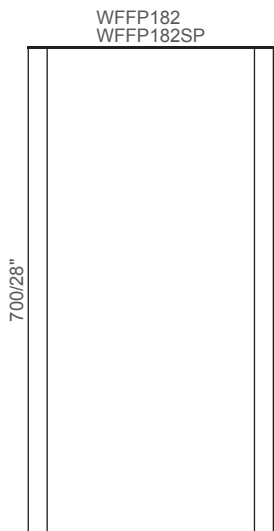
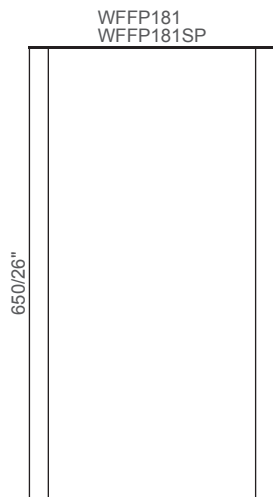
F14 ③④⑧⑨



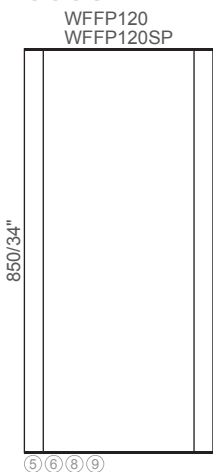
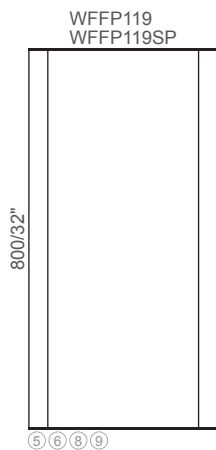
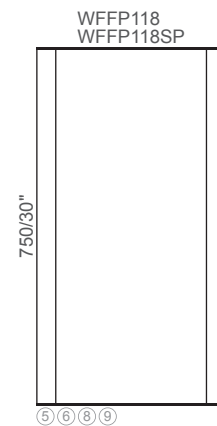
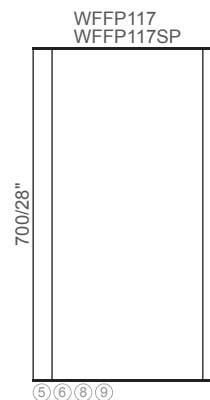
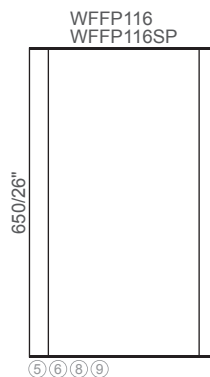
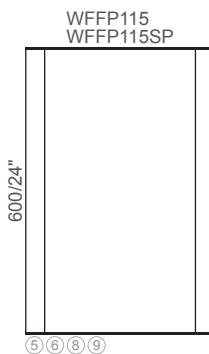
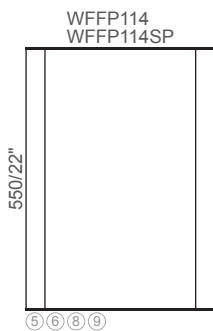
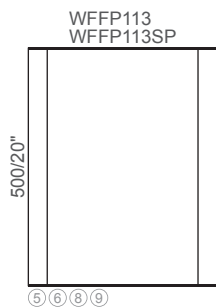
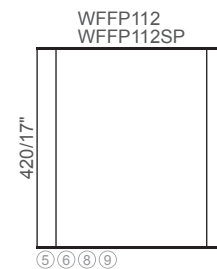
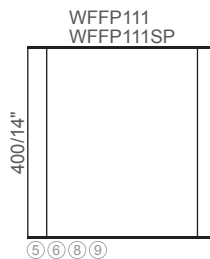
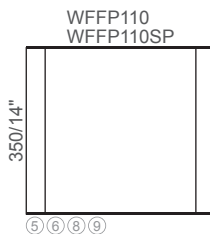
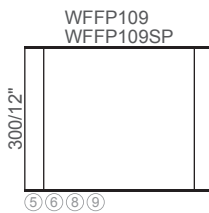
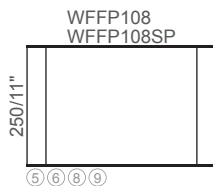
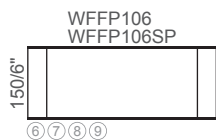
① Please consult the graphic implementation legend on page 2.

F14 ③④⑧⑨

 Floating wall frame portrait **WFFPSP**
 Wall frame portrait **WFFP**


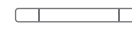


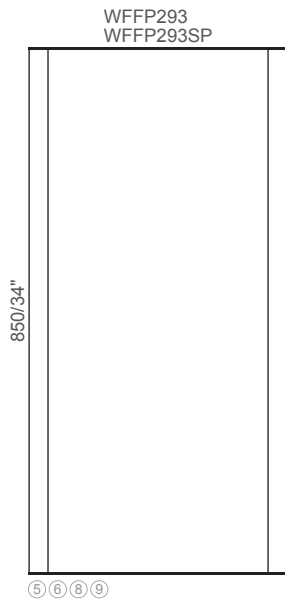
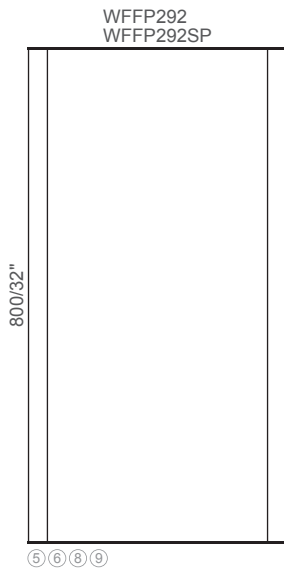
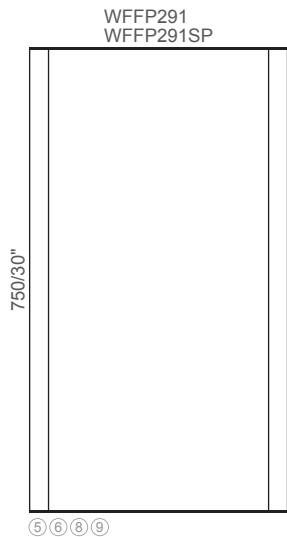
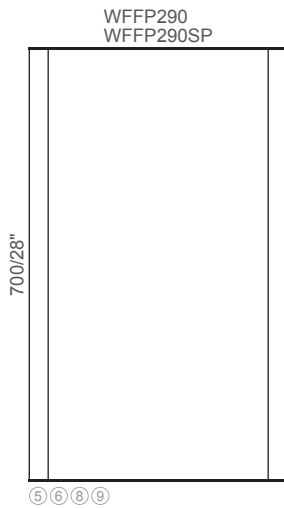
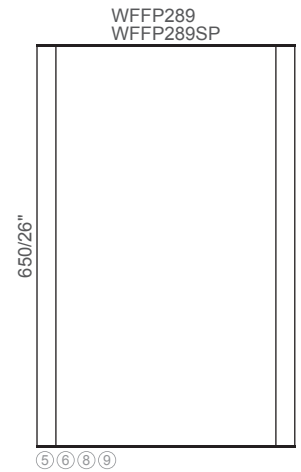
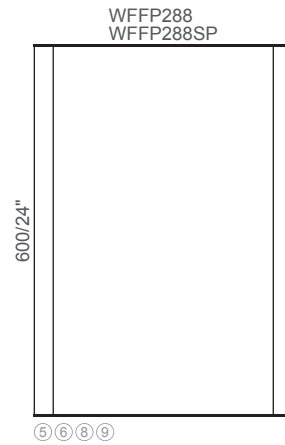
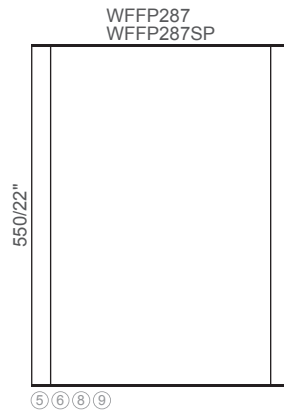
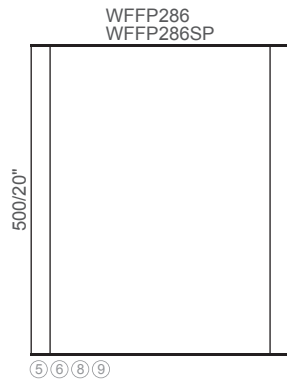
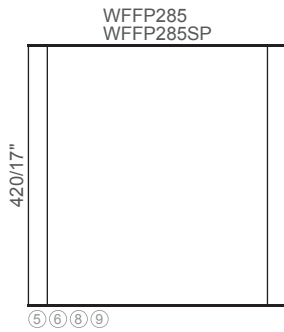
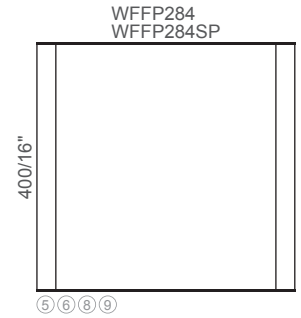
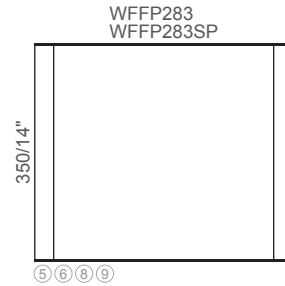
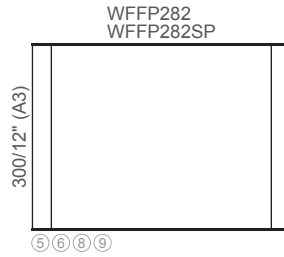
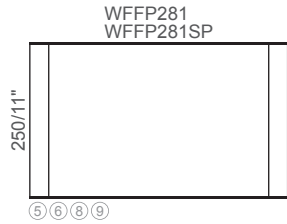
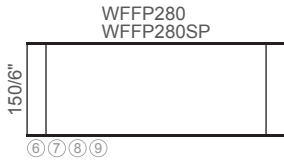
F400



① Please consult the graphic implementation legend on page 2.

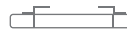

F420

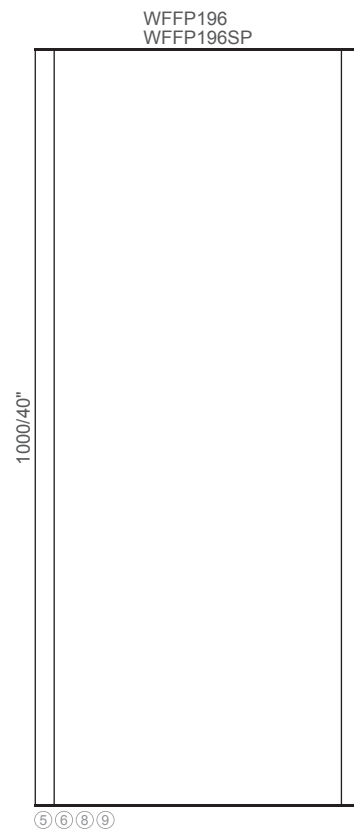
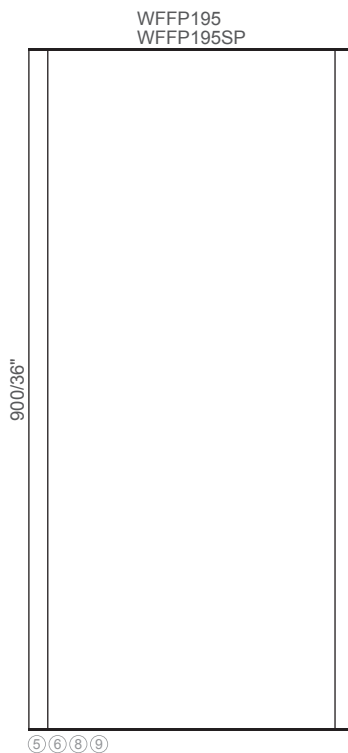
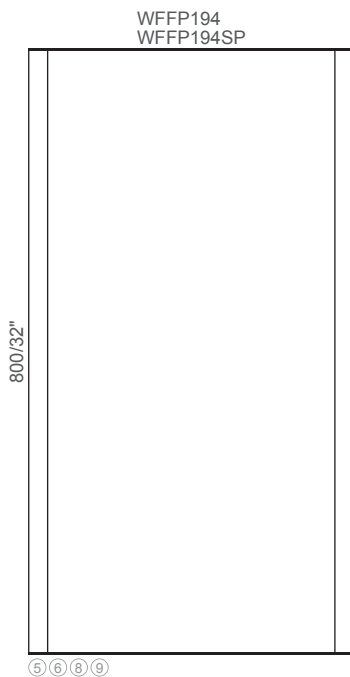
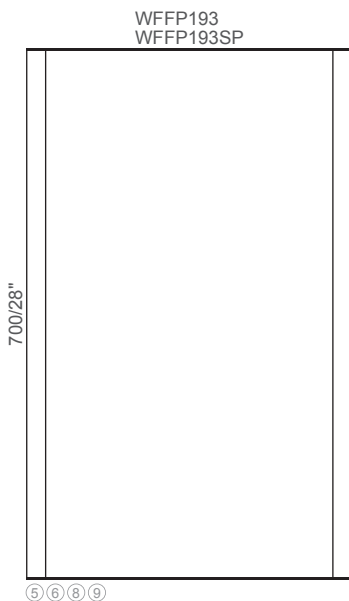
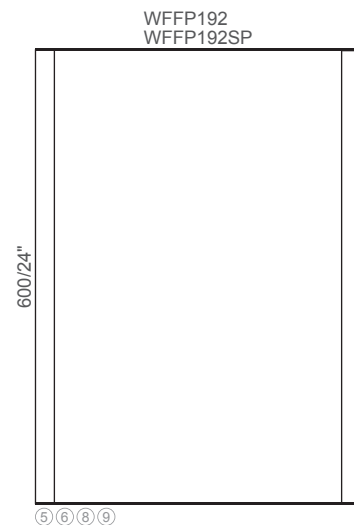
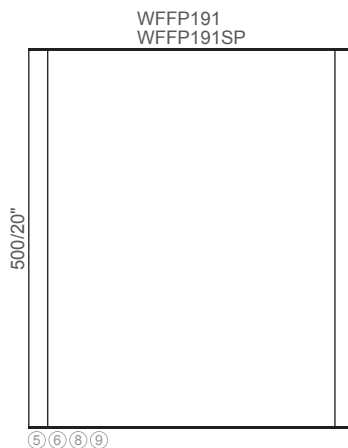
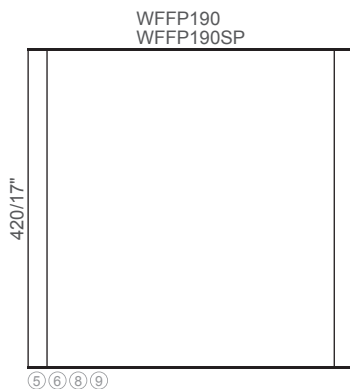
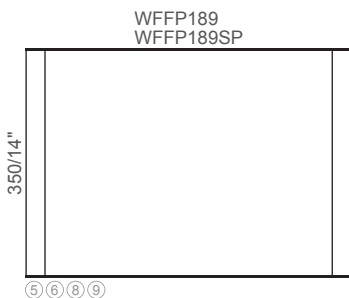
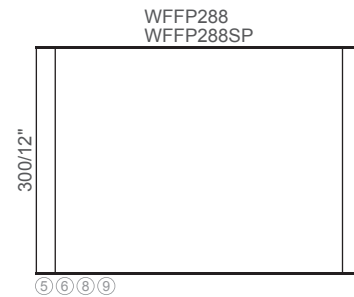
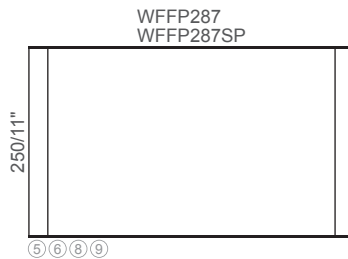
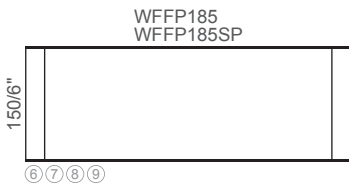
 Floating wall frame portrait **WFFPSP**
 Wall frame portrait **WFFP**



① Please consult the graphic implementation legend on page 2.

F17

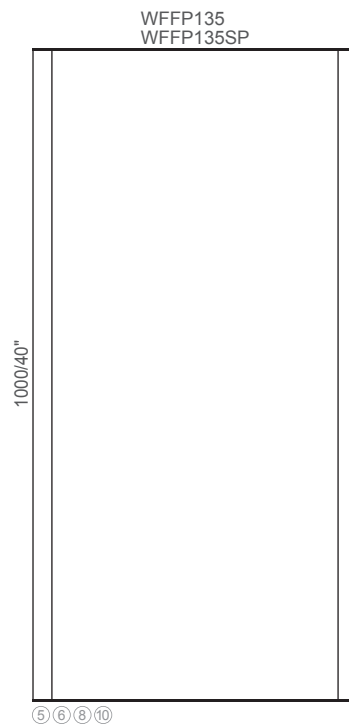
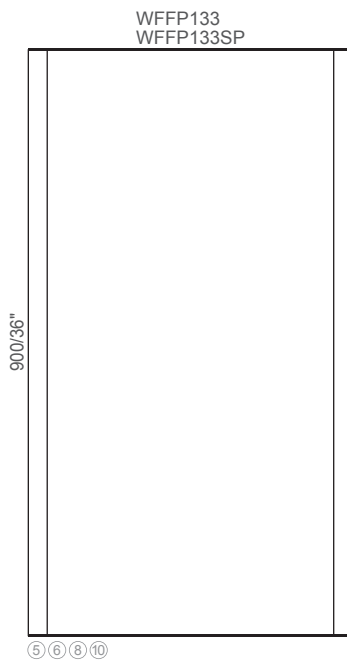
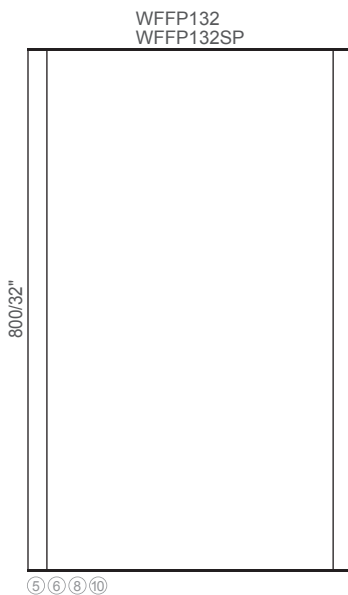
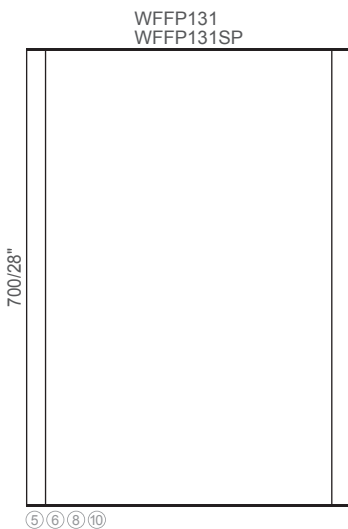
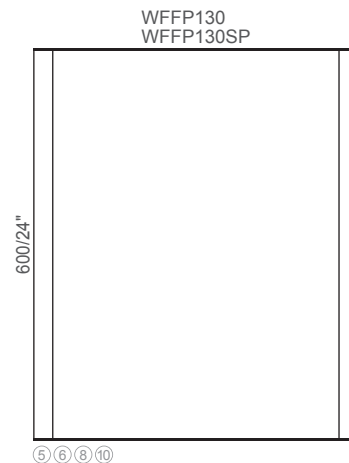
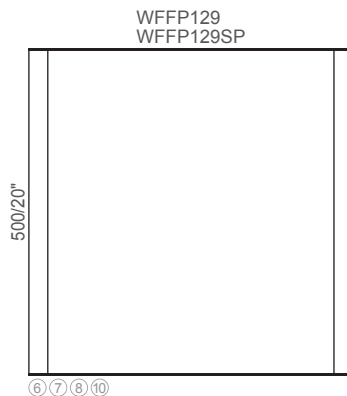
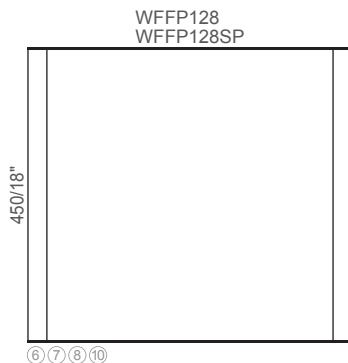
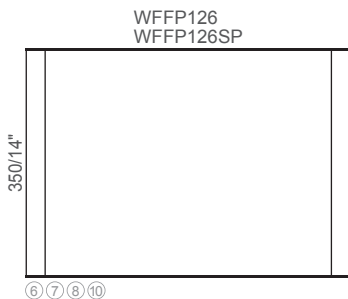
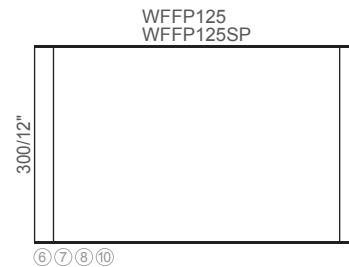
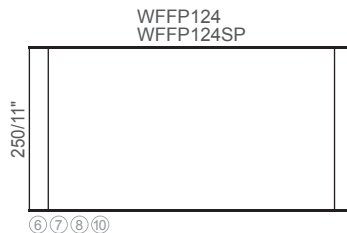
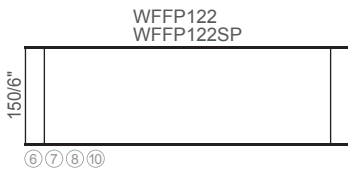
 Floating wall frame portrait **WFFPSP**
 Wall frame portrait **WFFP**



① Please consult the graphic implementation legend on page 2.

F500

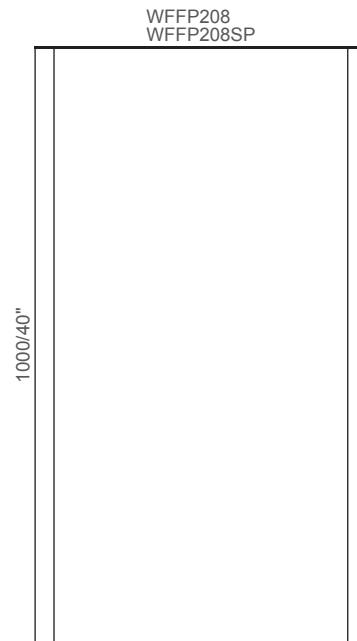
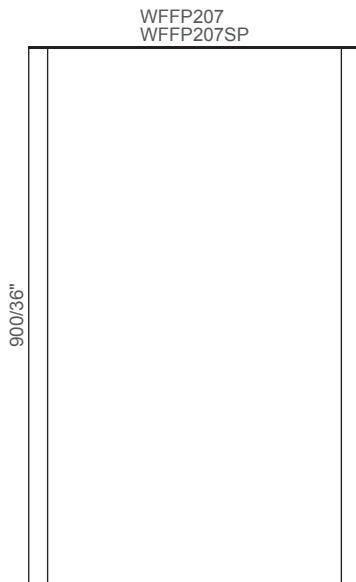
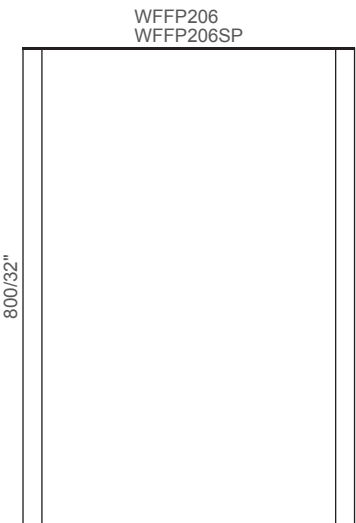
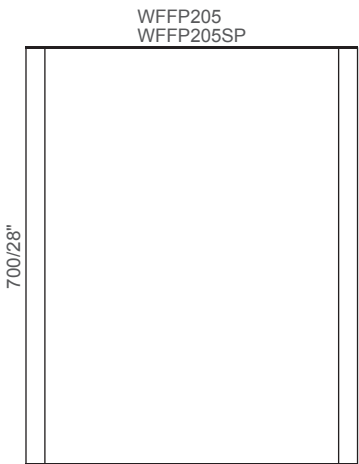
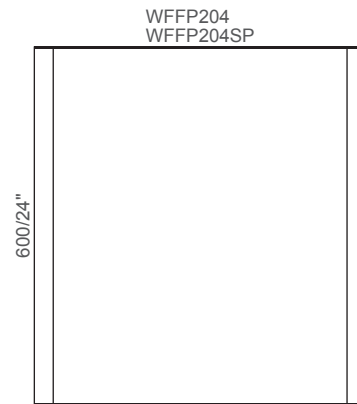
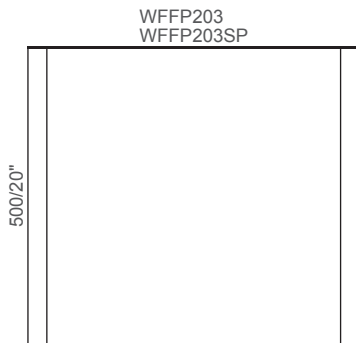
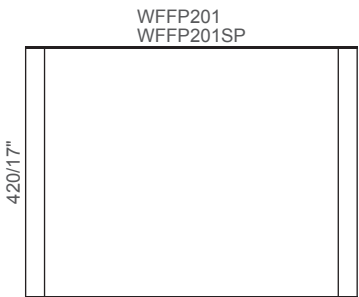
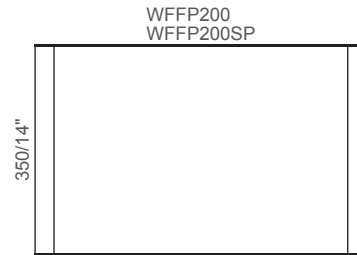
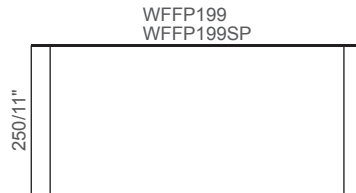
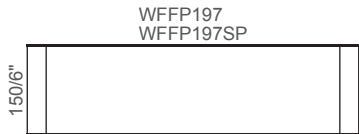
Floating wall frame portrait **WFFPSP**
 Wall frame portrait **WFFP**



① Please consult the graphic implementation legend on page 2.

F22 ⑥ ⑦ ⑧ ⑩

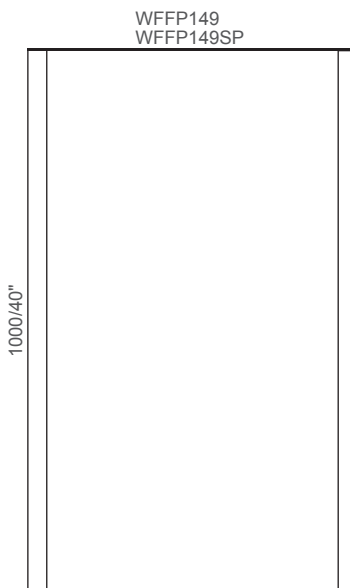
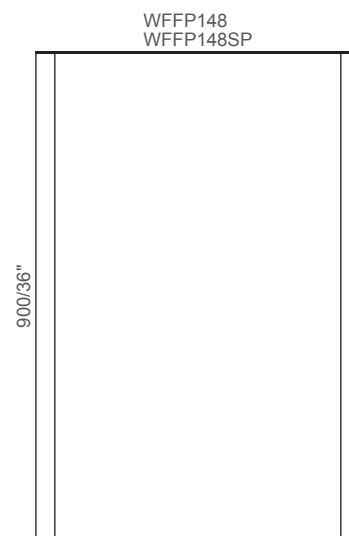
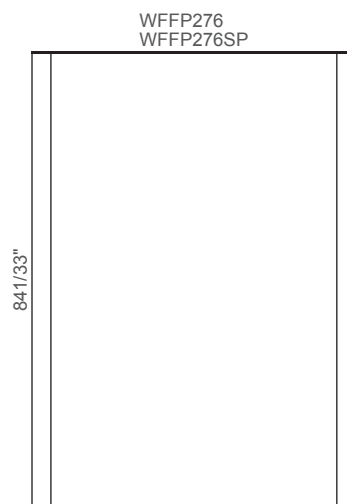
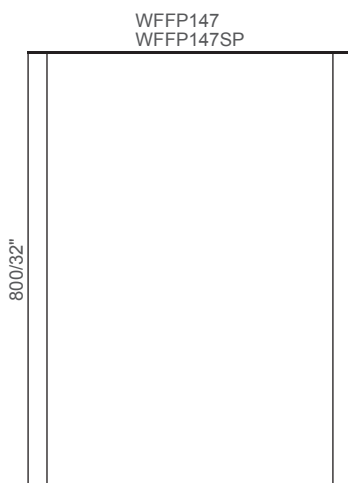
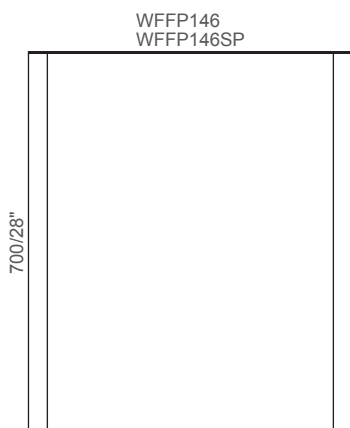
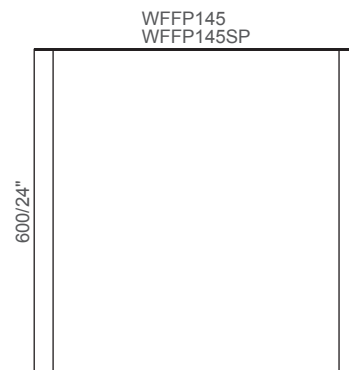
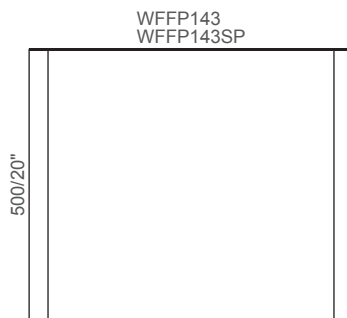
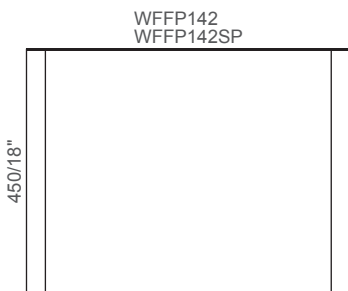
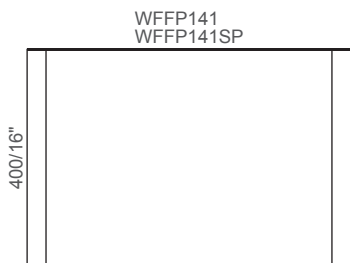
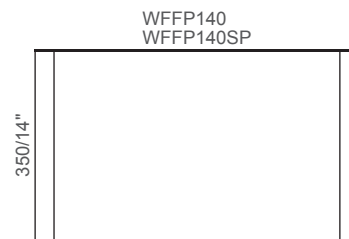
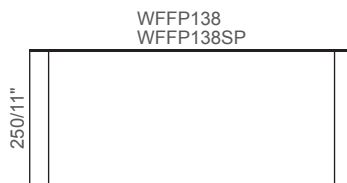
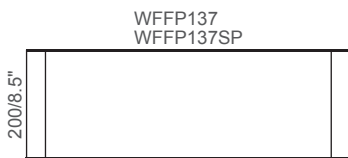
Floating wall frame portrait **WFFPSP**
 Wall frame portrait **WFFP**



ⓘ Please consult the graphic implementation legend on page 2.



F600 ⑥ ⑦ ⑧ ⑩

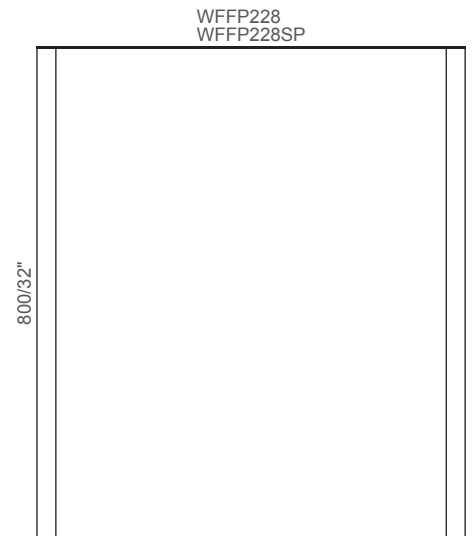
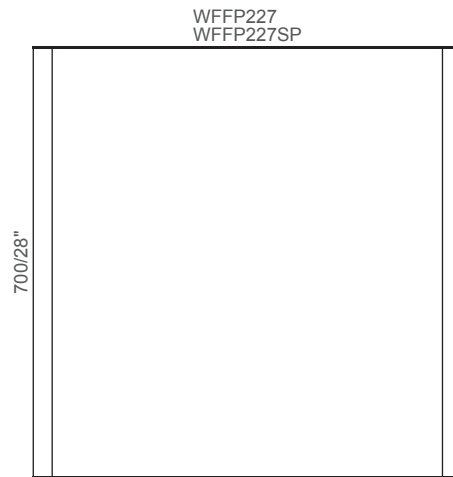
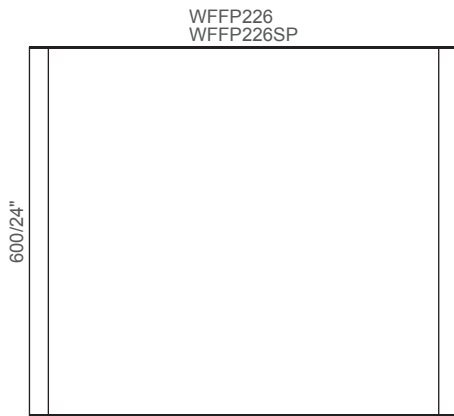
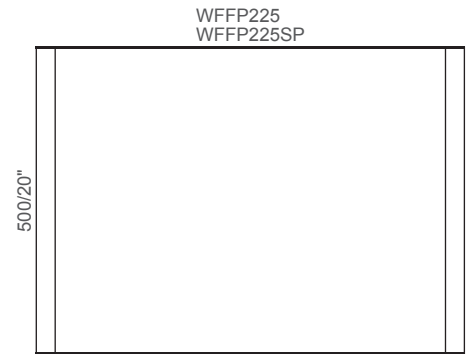
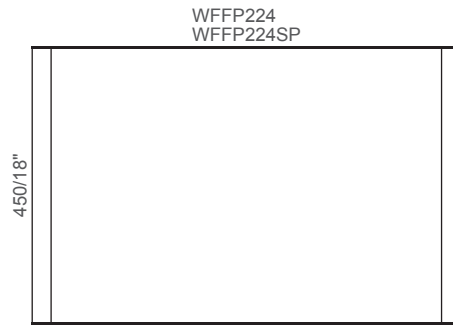
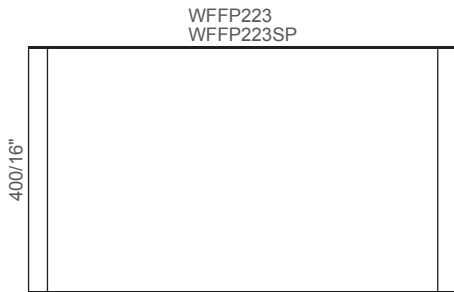
Floating wall frame portrait **WFFPSP**
 Wall frame portrait **WFFP**



① Please consult the graphic implementation legend on page 2.



F700 ⑥ ⑧ ⑩

 Floating wall frame portrait **WFFPSP**
 Wall frame portrait **WFFP**

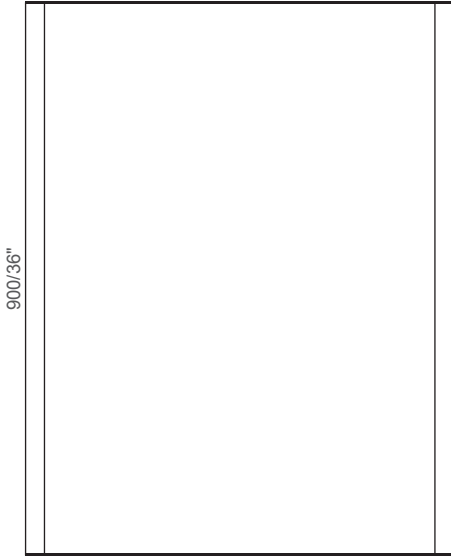


① Please consult the graphic implementation legend on page 2.

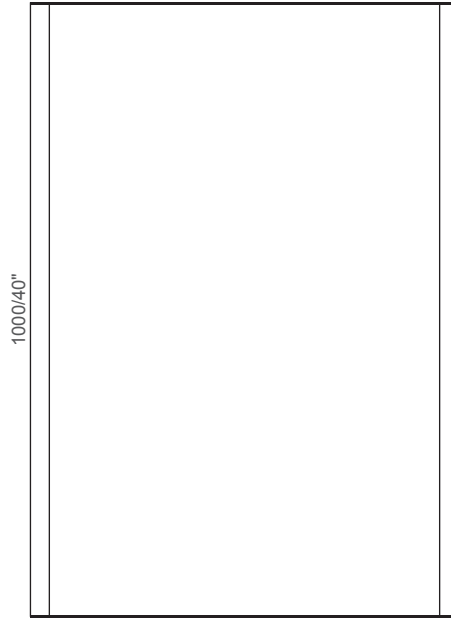
F700 ⑥ ⑧ ⑩

 Floating wall frame portrait **WFFPSP**
 Wall frame portrait **WFFP**

WFFP229
WFFP229SP



WFFP230
WFFP230SP



F800 ⑥ ⑧ ⑩

WFFP235
WFFP235SP



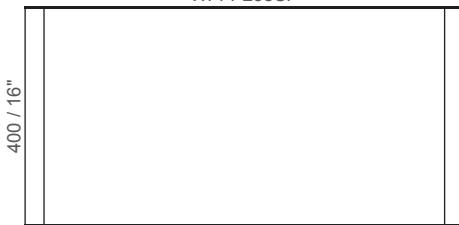
WFFP236
WFFP236SP



WFFP237
WFFP237SP



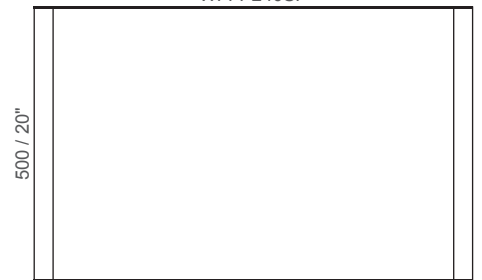
WFFP238
WFFP238SP



WFFP239
WFFP239SP





WFFP240
WFFP240SP

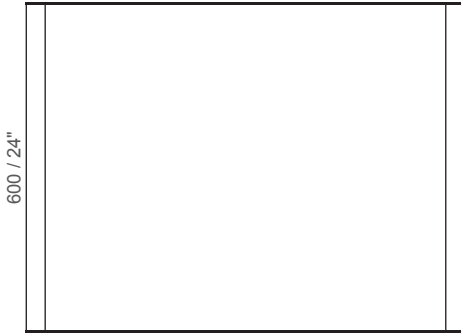


① Please consult the graphic implementation legend on page 2.

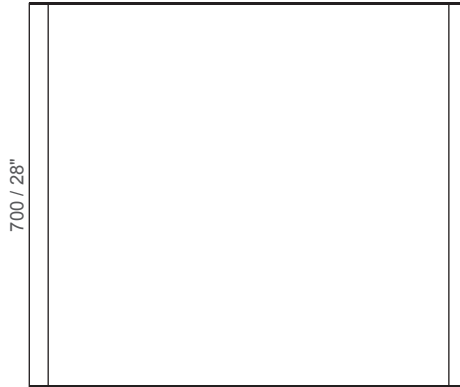
F800 ⑥ ⑧ ⑩

 Floating wall frame portrait **WFFPSP**
 Wall frame portrait **WFFP**

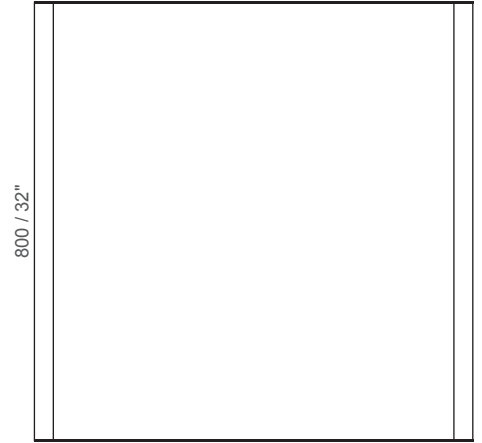
WFFP241
WFFP241SP



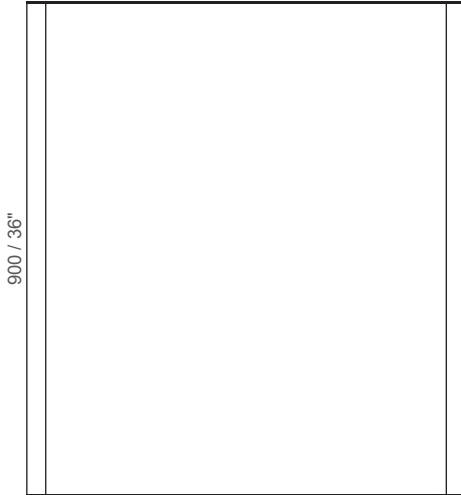
WFFP242
WFFP242SP



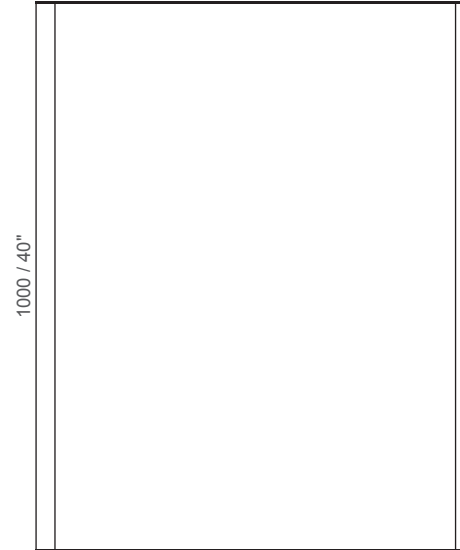
WFFP243
WFFP243SP



WFFP244
WFFP244SP





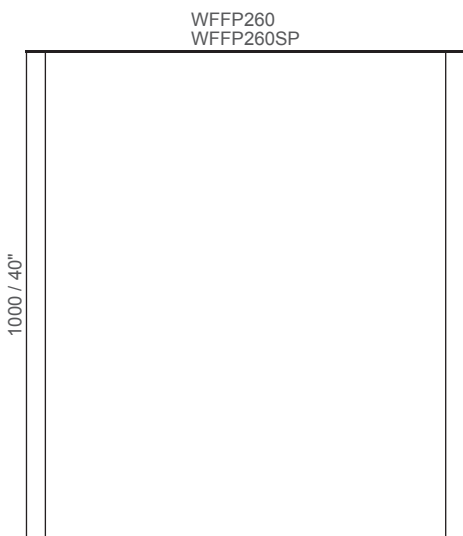
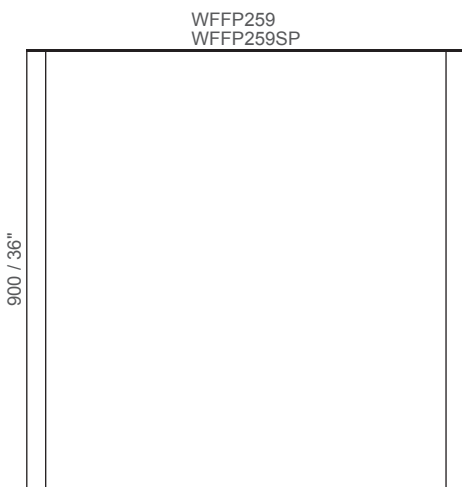
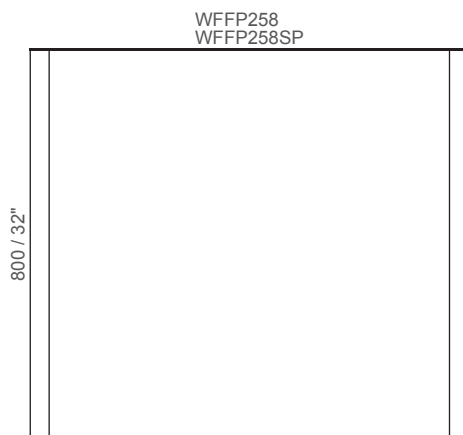
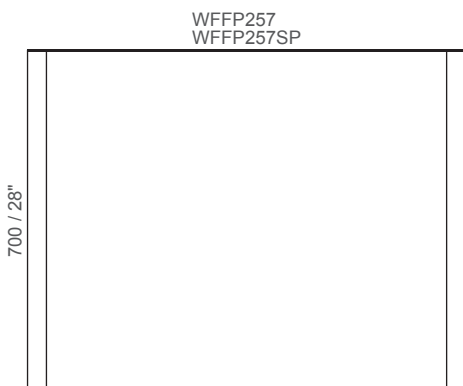
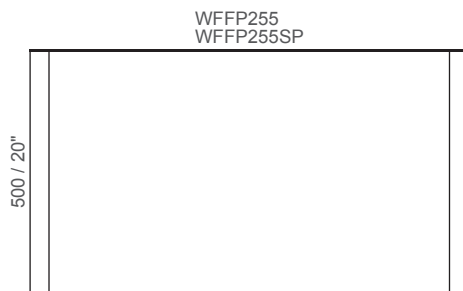
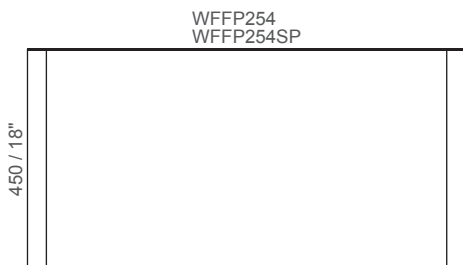
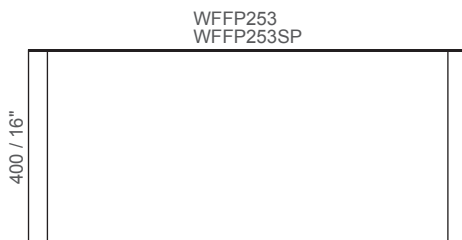
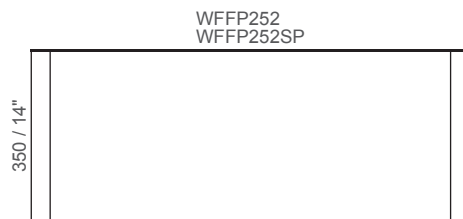
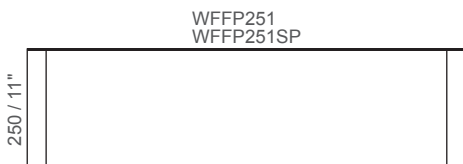
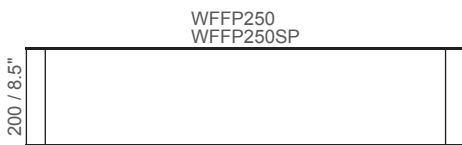
WFFP245
WFFP245SP



ⓘ Please consult the graphic implementation legend on page 2.


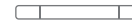
F900 ⑥ ⑧ ⑩

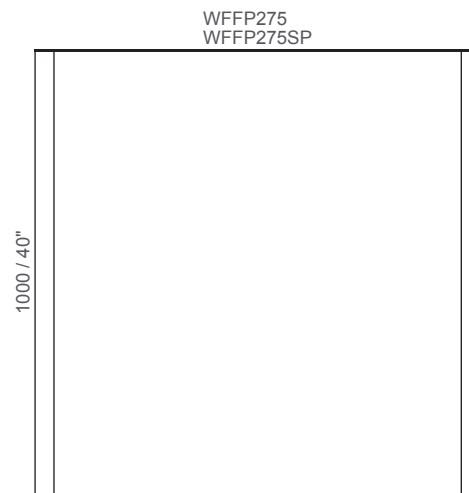
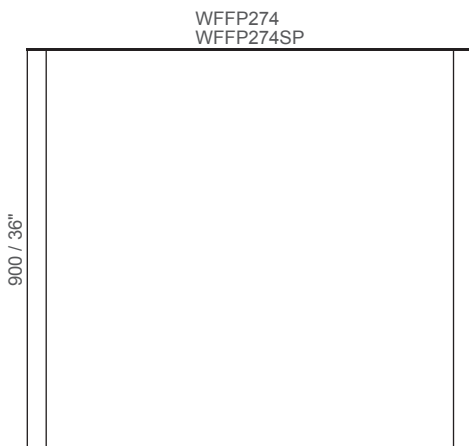
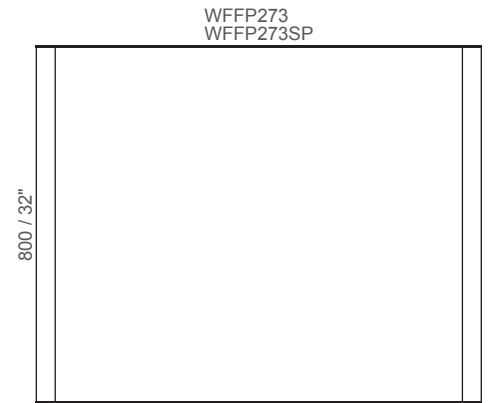
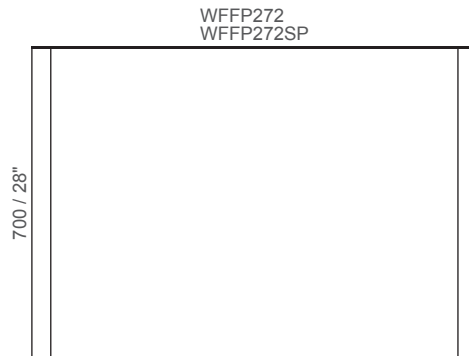
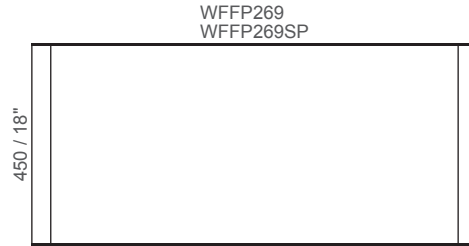
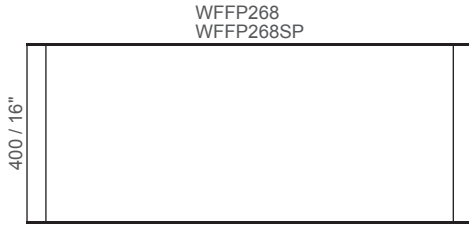
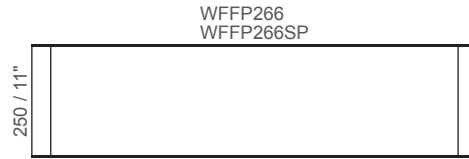
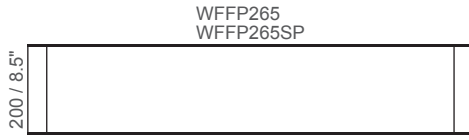
 Floating wall frame portrait **WFFPSP**
 Wall frame portrait **WFFP**



① Please consult the graphic implementation legend on page 2.

F1000 ⑥ ⑧ ⑩

 Floating wall frame portrait **WFFPSP**
 Wall frame portrait **WFFP**

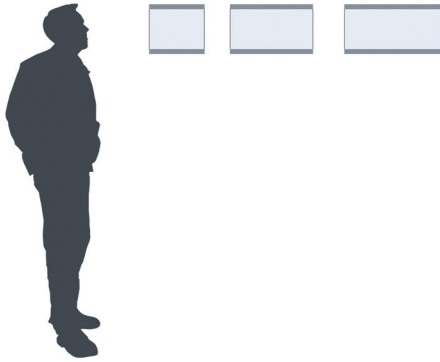


① Please consult the graphic implementation legend on page 2.

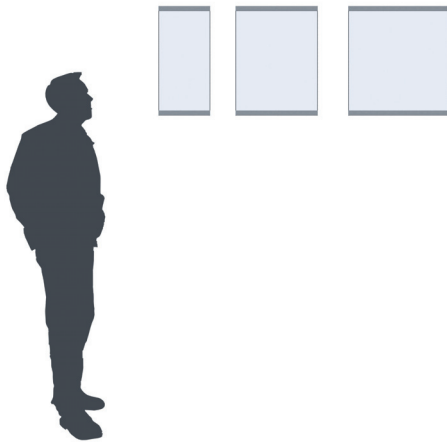


The GreenSquare landscape wall frames (also available in an eye catching floating design) are ideal for room identification, bathroom signage and general wayfinding. The end caps on the top and bottom of the sign frame determine the landscape position.

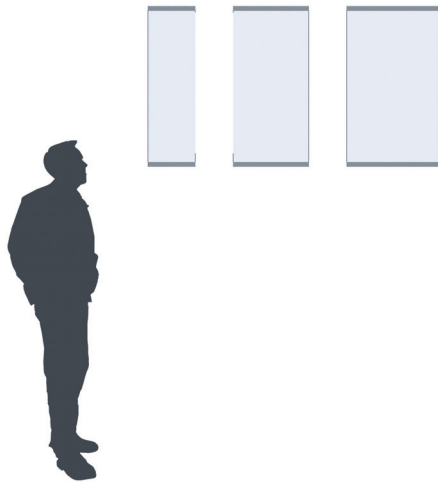
WFF-Letter-L



WFF-500-L



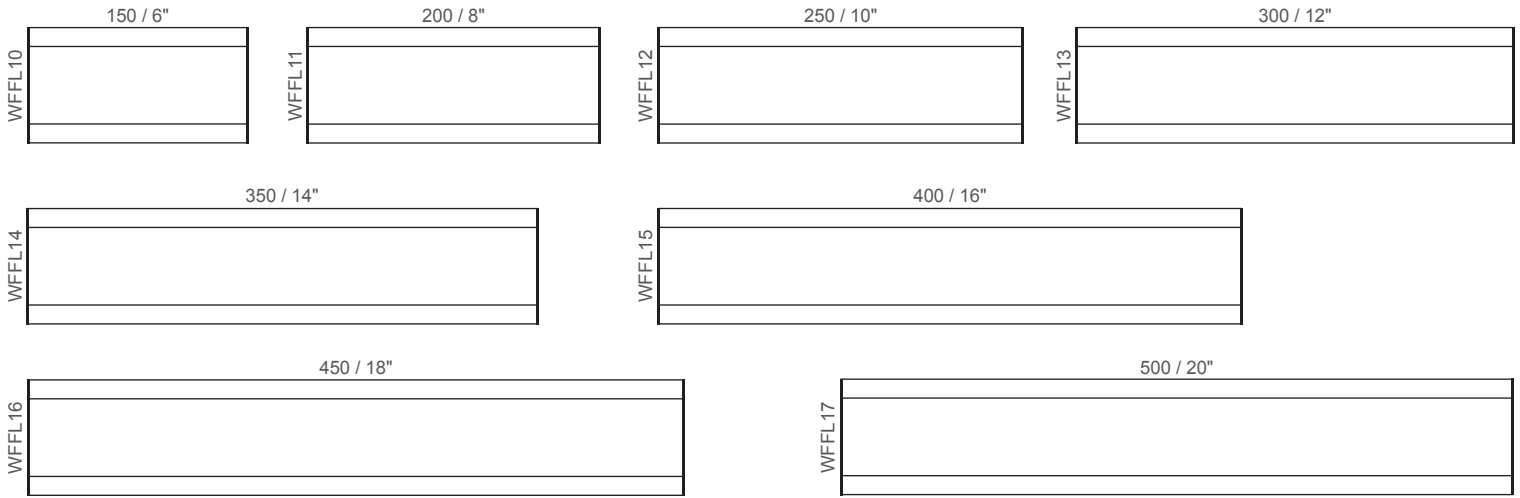
WFF-800-L



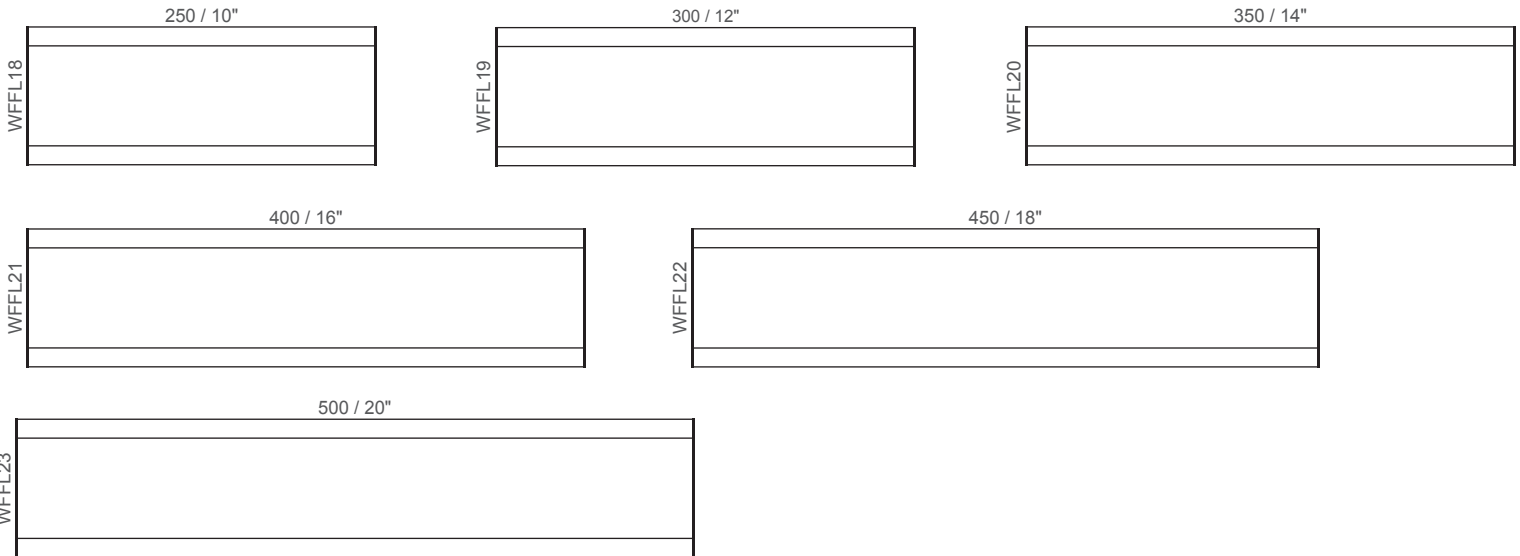
All products on this page are also available in floating version (catalog number: WFFLSP)

Floating wall frame landscape **WFFLSP**
 Wall frame landscape **WFFL**

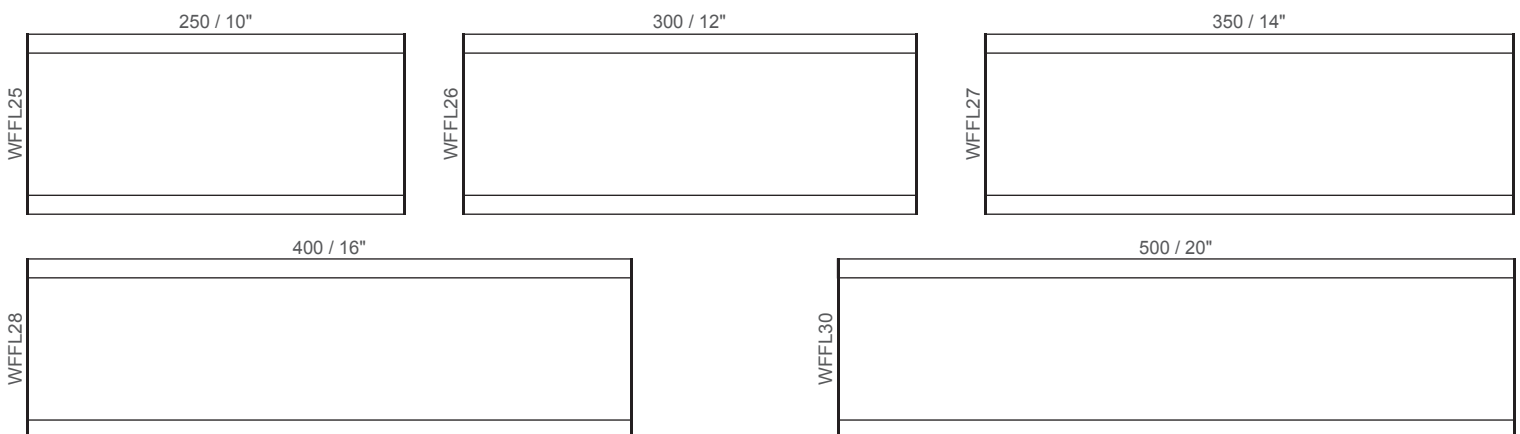
F80 ① ② ⑧ ⑨



F100 ① ② ⑧ ⑨



F120 ③ ④ ⑧ ⑨

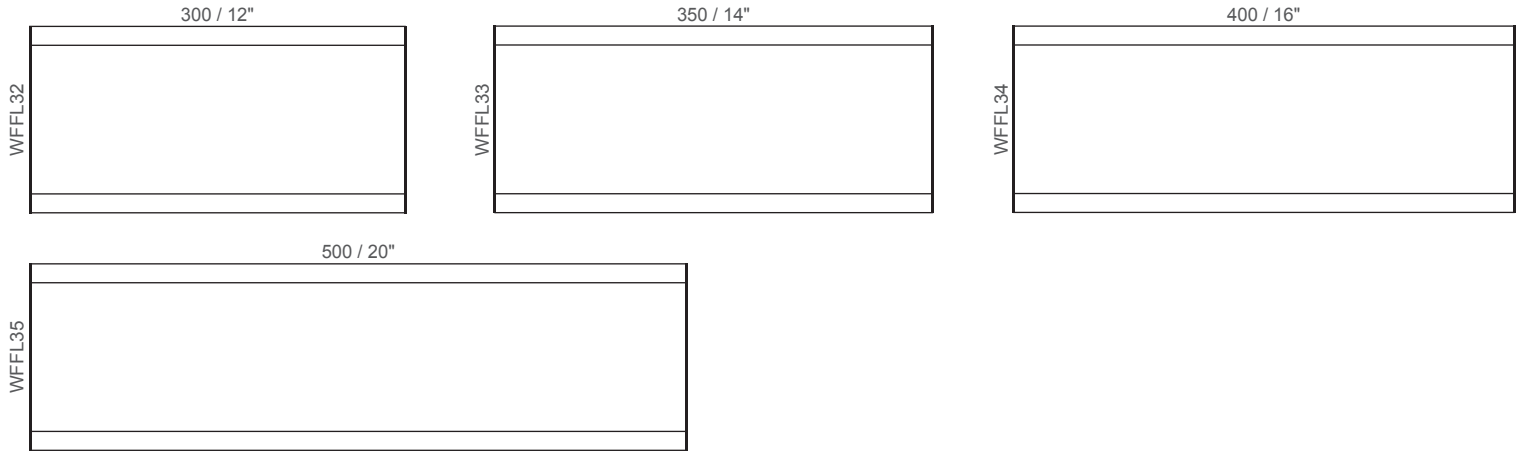


① Please consult the graphic implementation legend on page 2.

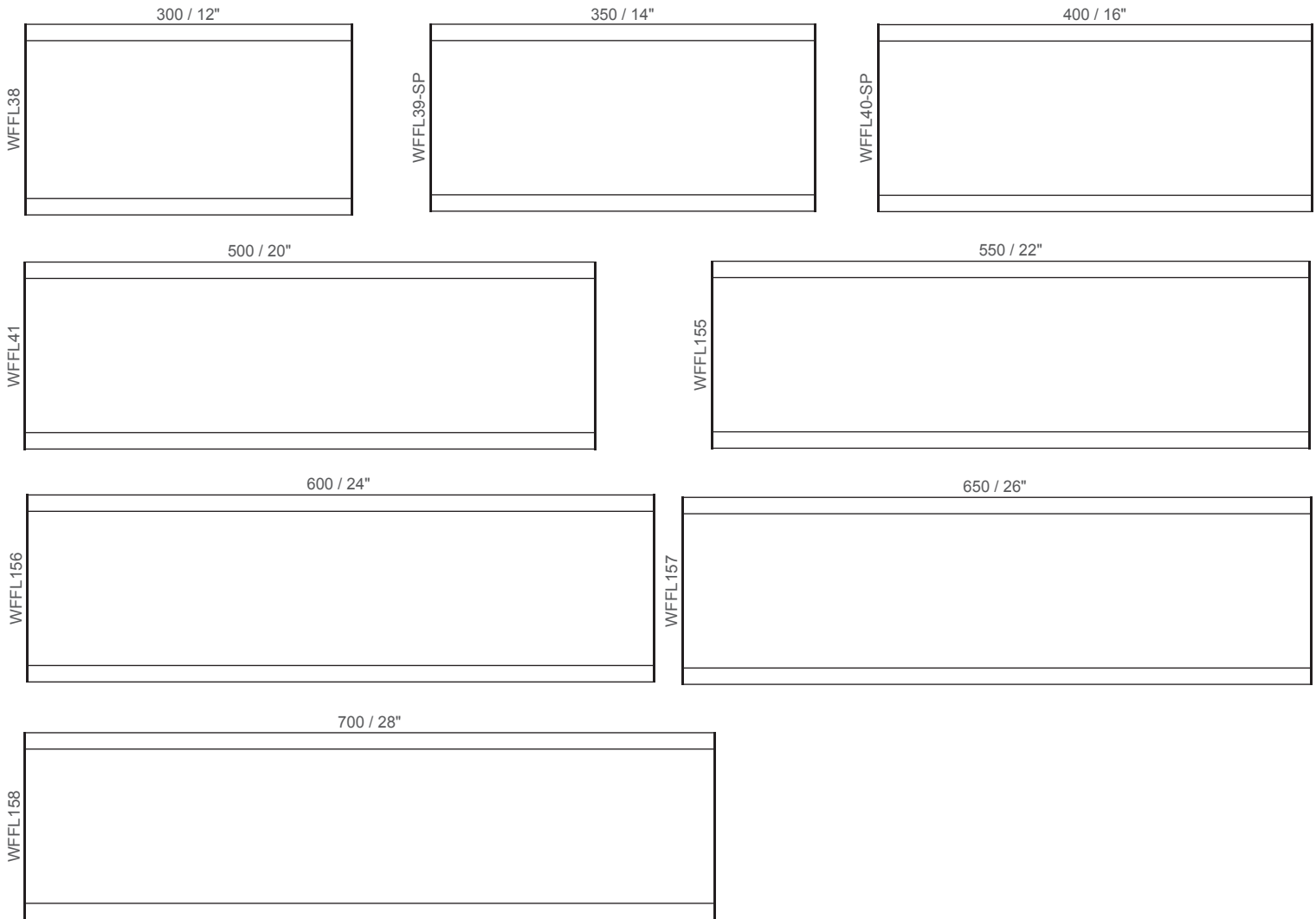
All products on this page are also available in floating version (catalog number: WFFLSP)

Floating wall frame landscape **WFFLSP**
 Wall frame landscape **WFFL**

F150 ③ ④ ⑧ ⑨



F200 ③ ④ ⑧ ⑨

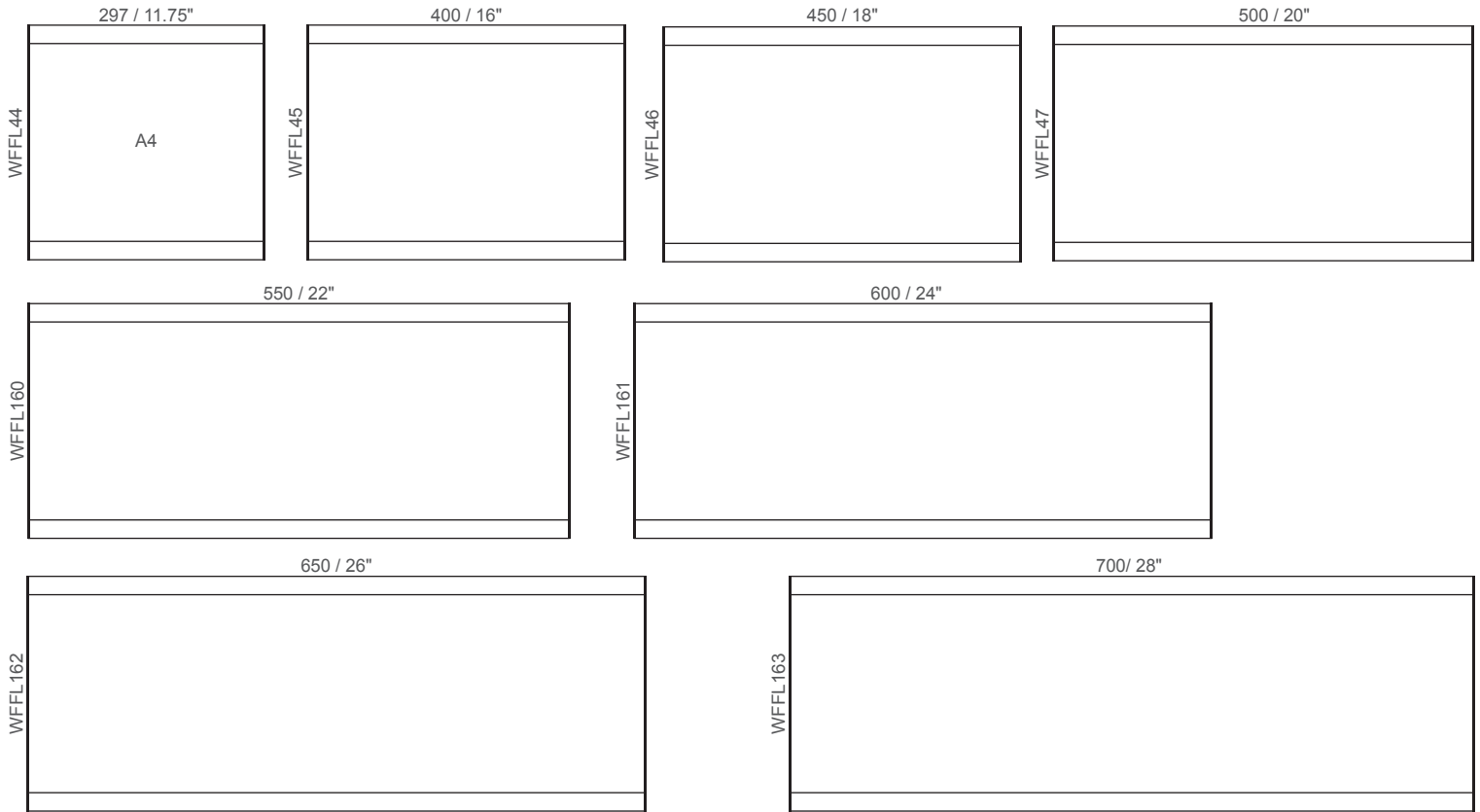


① Please consult the graphic implementation legend on page 2.

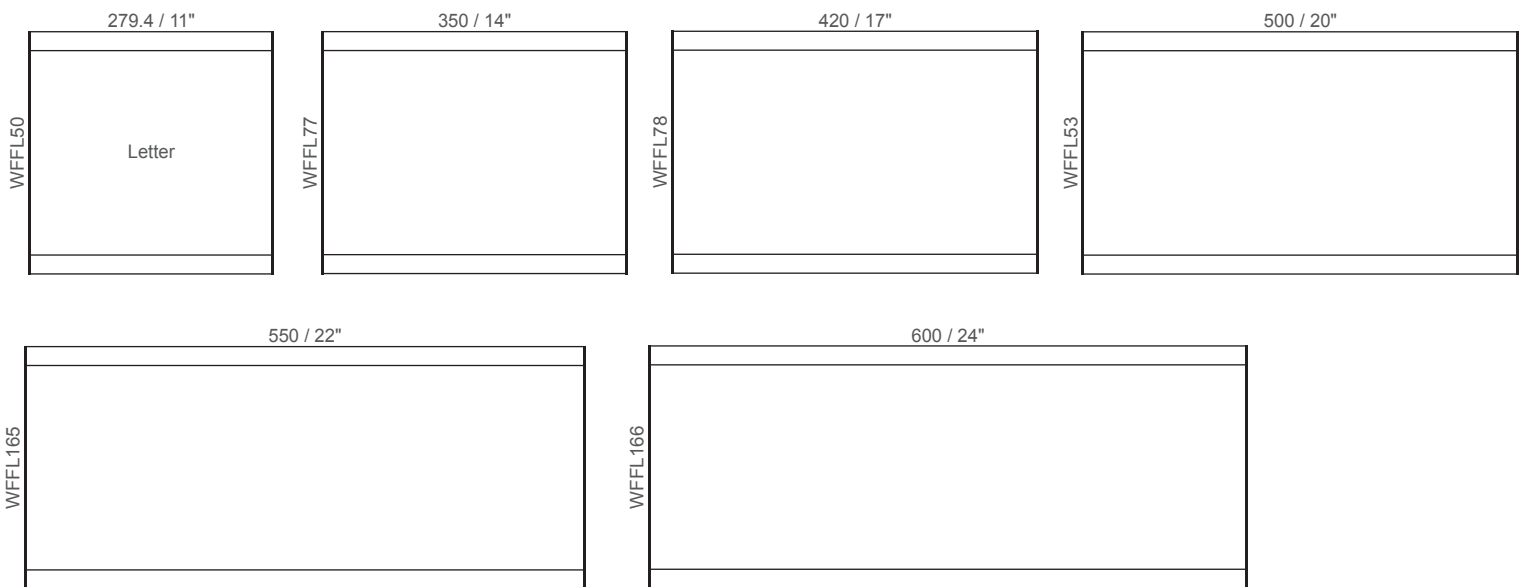
All products on this page are also available in floating version (catalog number: WFFLSP)

Floating wall frame landscape **WFFLSP**
 Wall frame landscape **WFFL**

F-A4 ③ ④ ⑧ ⑨



F-Letter ③ ④ ⑧ ⑨

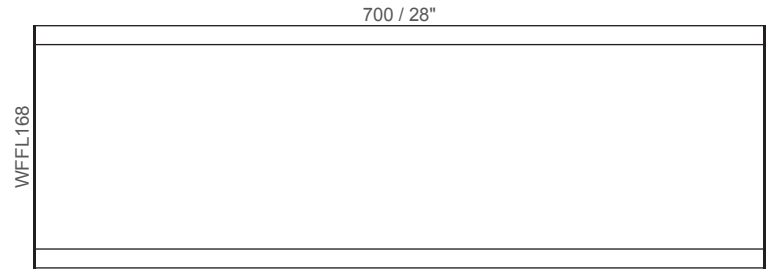
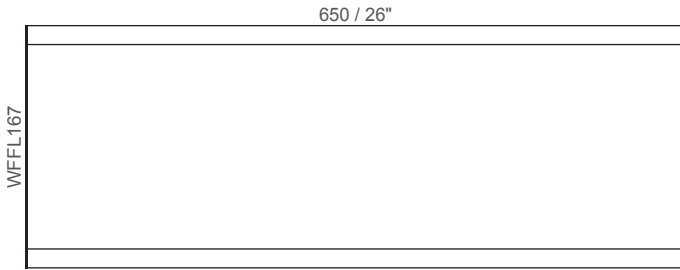


① Please consult the graphic implementation legend on page 2.

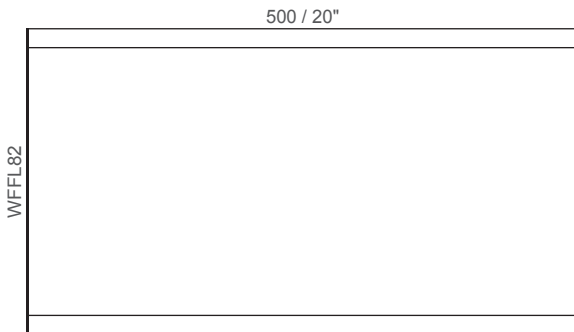
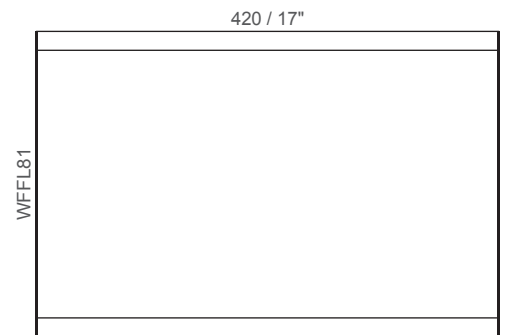
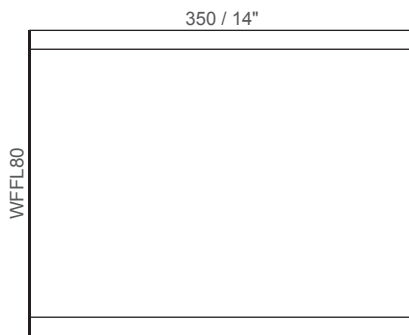
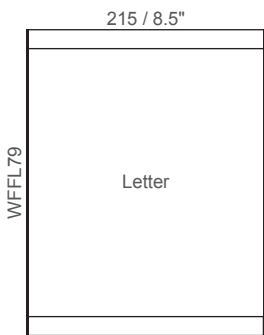
All products on this page are also available in floating version (catalog number: WFFLSP)

F-Letter ③ ④ ⑧ ⑨

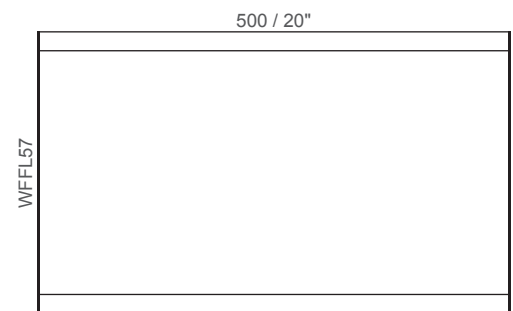
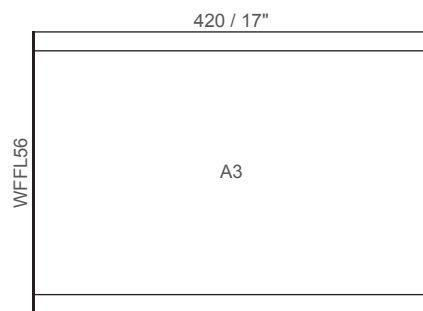
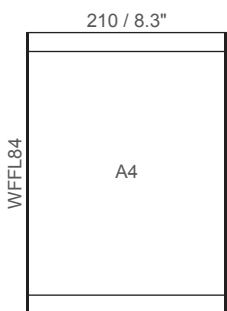
Floating wall frame landscape **WFFLSP**
 Wall frame landscape **WFFL**



F11 ③ ④ ⑧ ⑨



F300 ③ ④ ⑧ ⑨

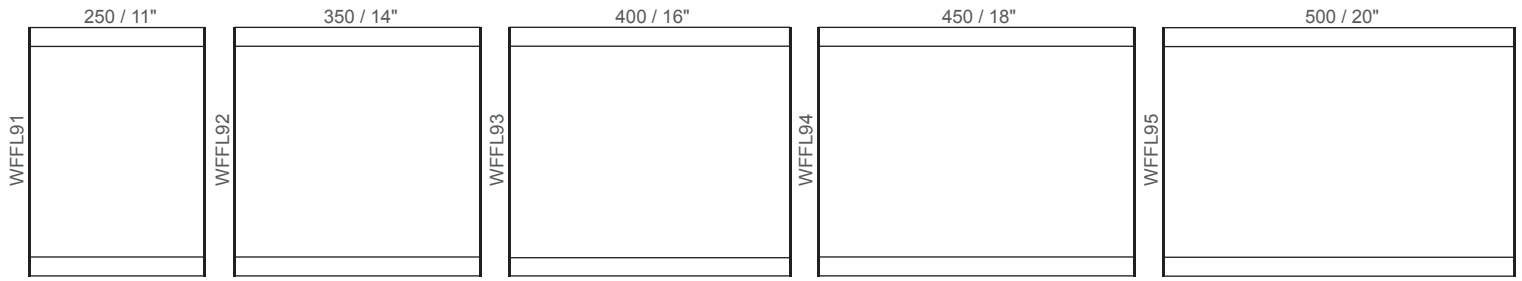


① Please consult the graphic implementation legend on page 2.

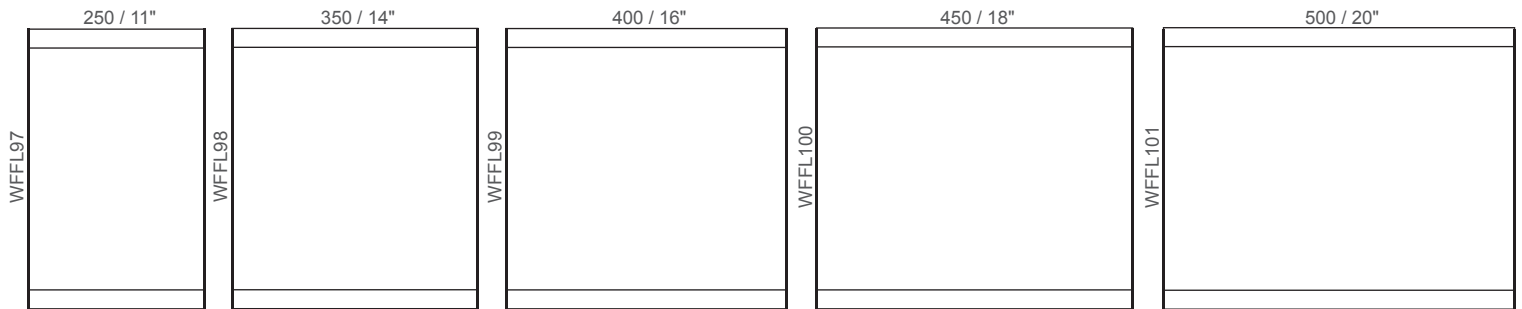
All products on this page are also available in floating version (catalog number: WFFLSP)

Floating wall frame landscape **WFFLSP**
 Wall frame landscape **WFFL**

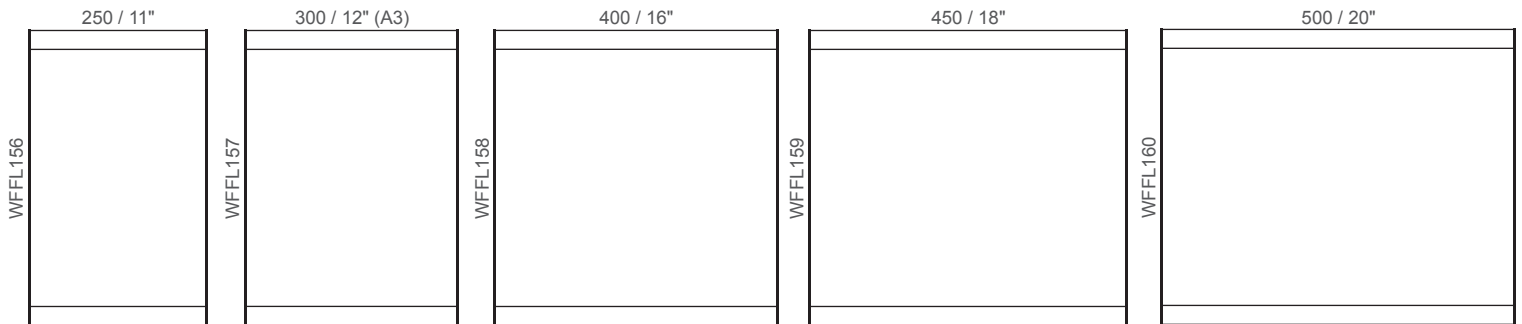
F14 ③ ④ ⑧ ⑨



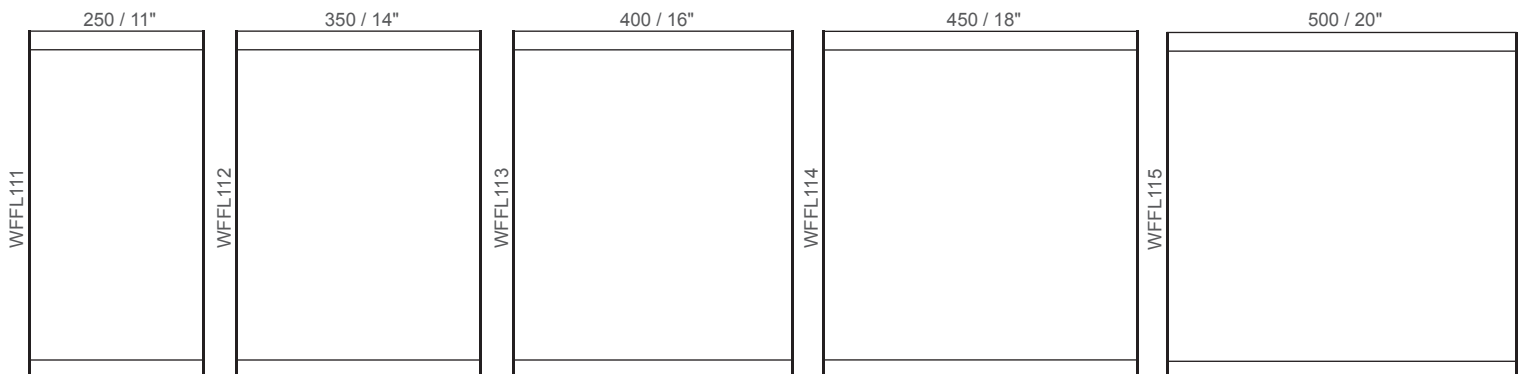
F400 ⑤ ⑥ ⑧ ⑨



F420 ⑤ ⑥ ⑧ ⑨



F500 ⑥ ⑦ ⑧ ⑩

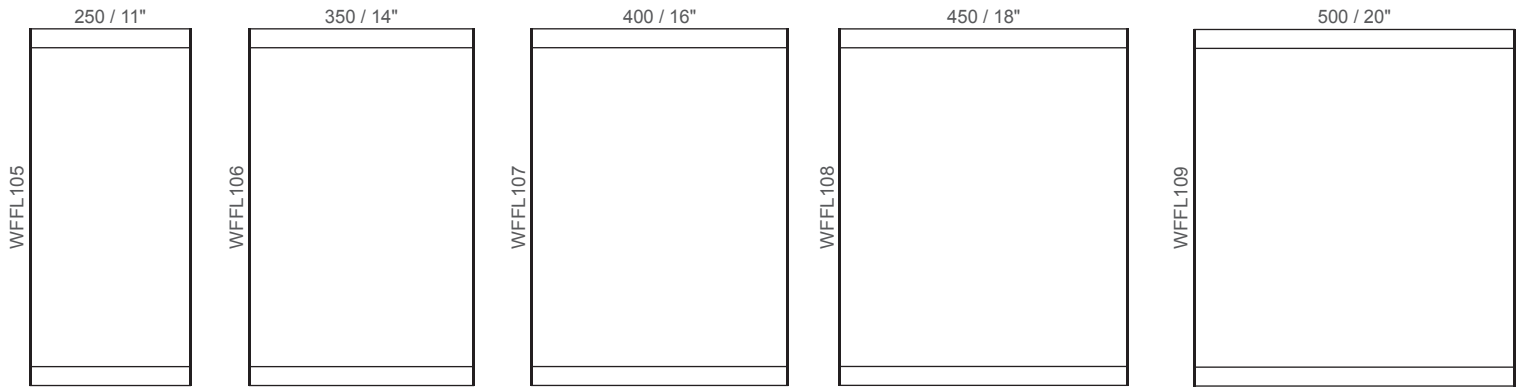


① Please consult the graphic implementation legend on page 2.

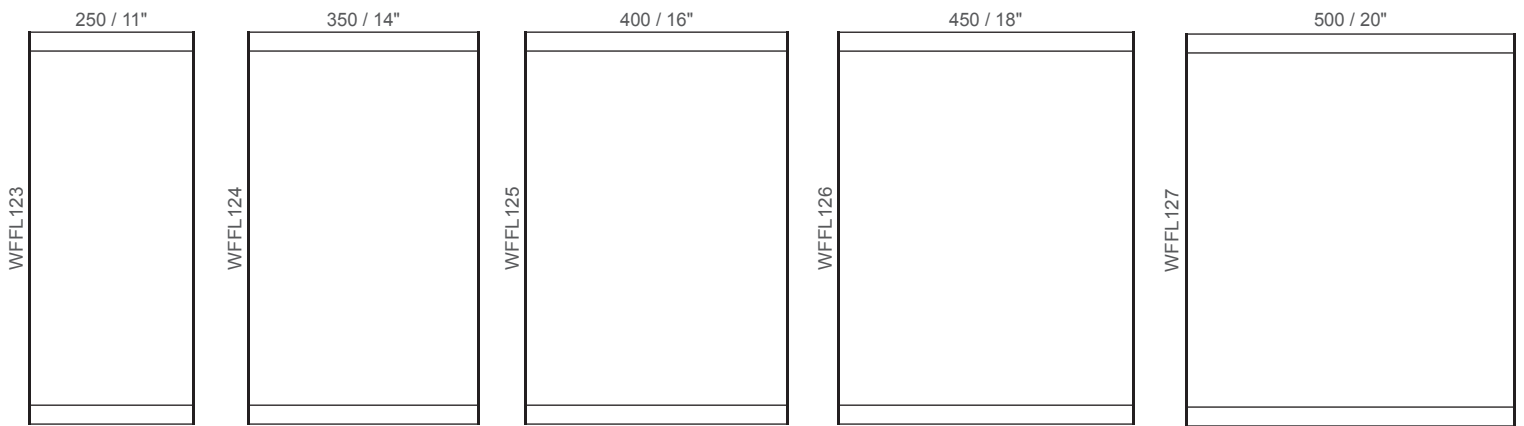
All products on this page are also available in floating version (catalog number: WFFLSP)

Floating wall frame landscape **WFFLSP**
 Wall frame landscape **WFFL**

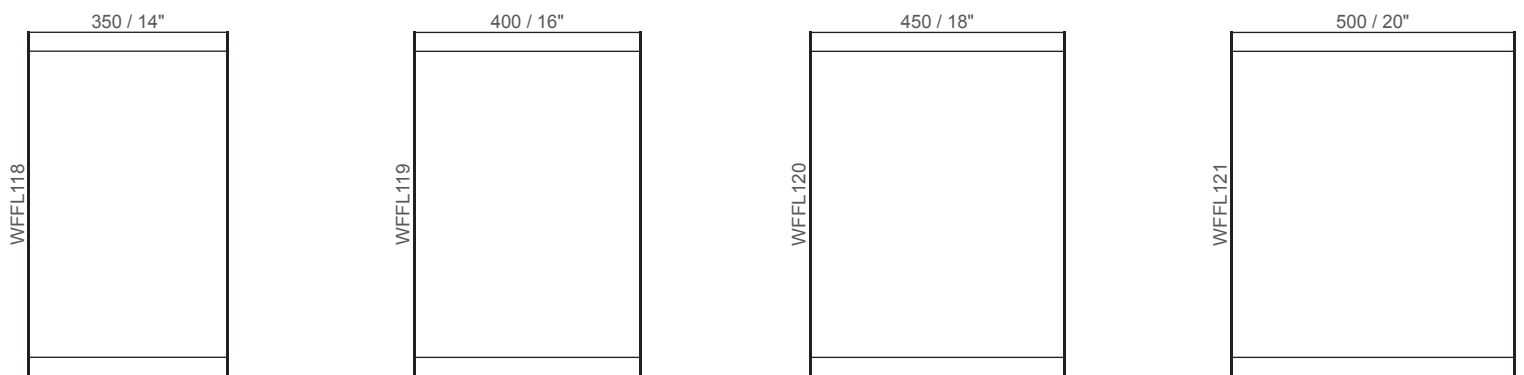
F22 ⑥ ⑦ ⑧ ⑩



F600 ⑥ ⑦ ⑧ ⑩


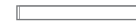


F24 ⑥ ⑦ ⑧ ⑩

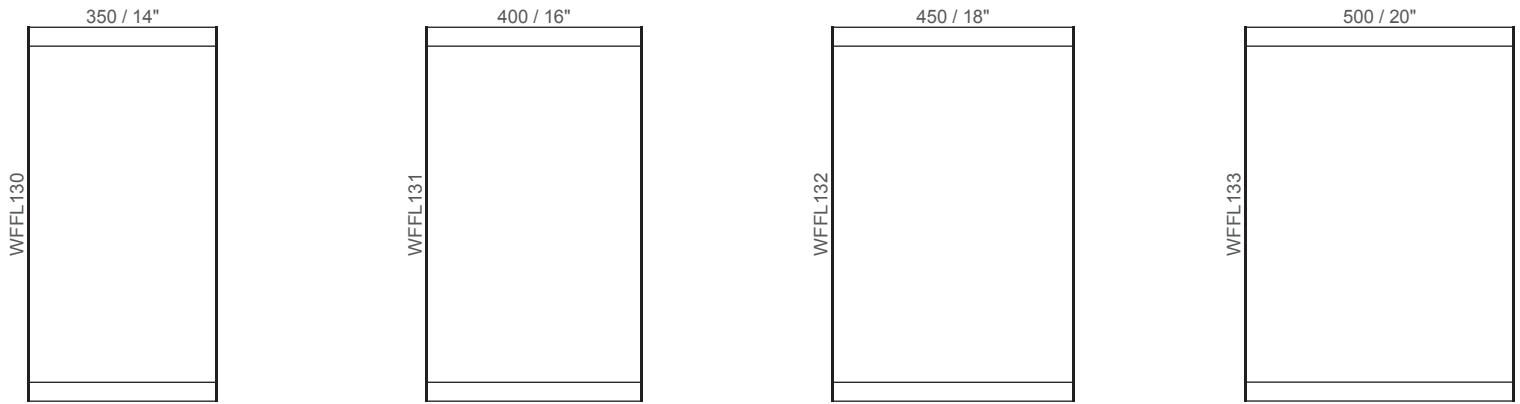


① Please consult the graphic implementation legend on page 2.

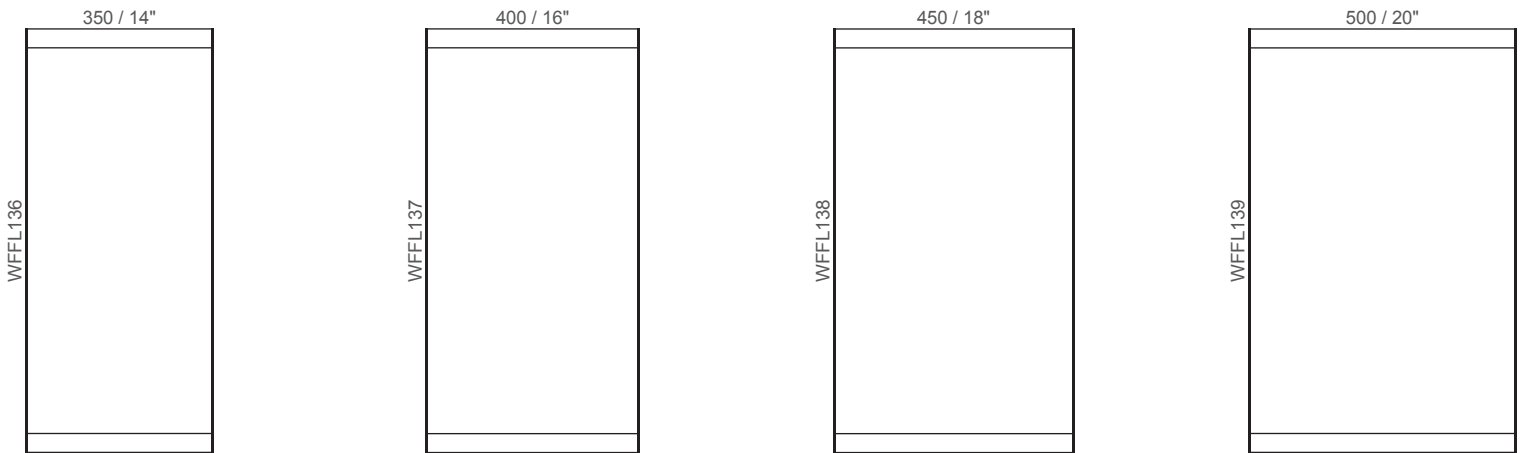
All products on this page are also available in floating version (catalog number: WFFLSP)

 Floating wall frame landscape **WFFLSP**
 Wall frame landscape **WFFL**

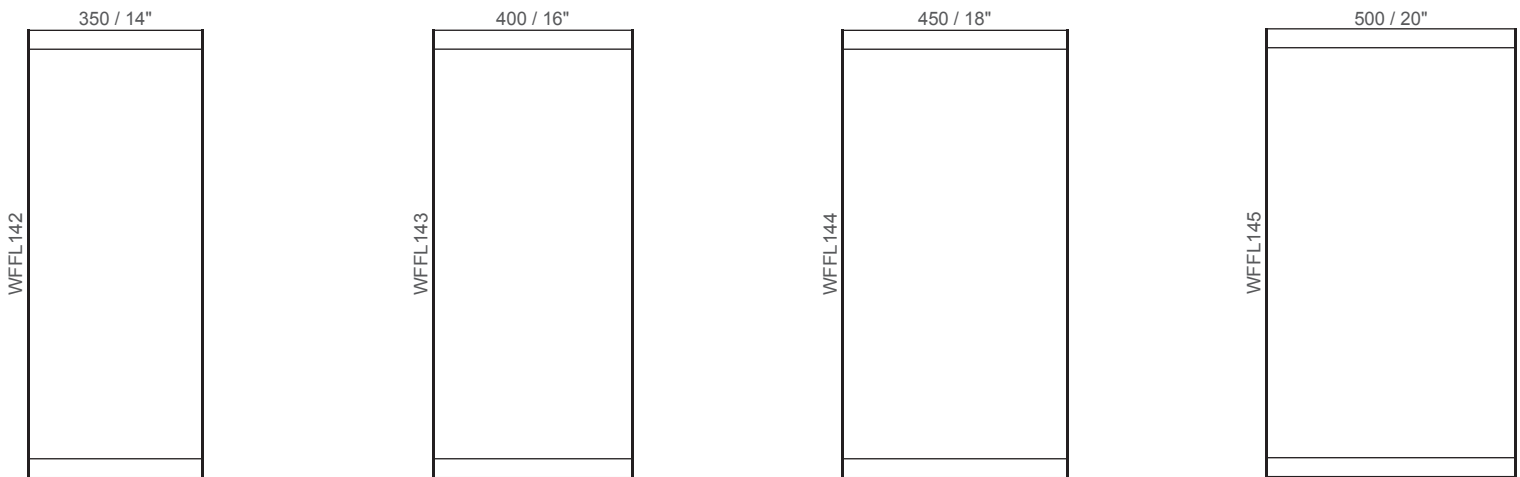
F700



F800





F900

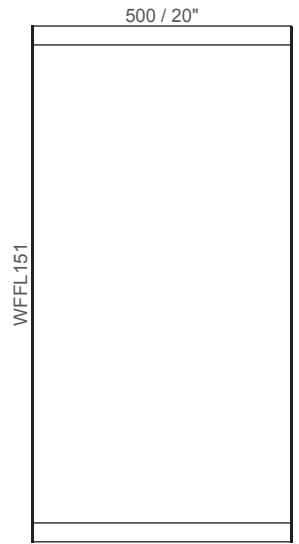
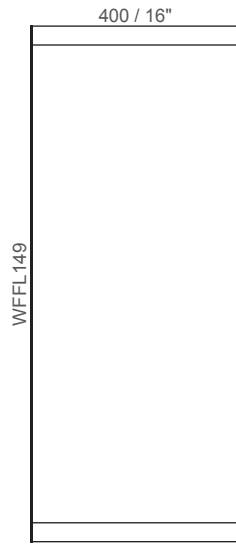


 Please consult the graphic implementation legend on page 2.

All products on this page are also available in floating version (catalog number: WFFLSP)

F1000 ⑥ ⑧ ⑩

 Floating wall frame landscape **WFFLSP**
 Wall frame landscape **WFFL**

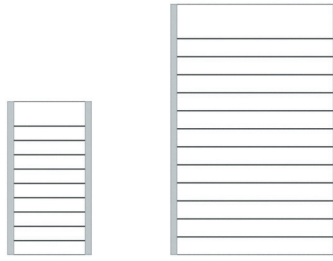


① Please consult the graphic implementation legend on page 2.

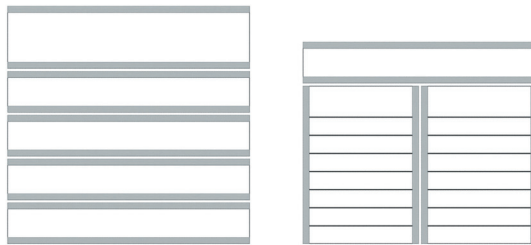


Directory signs are required throughout a building, starting from the reception area, through hallway directional directories and through office identification, in instances where several offices are entered via a single corridor.

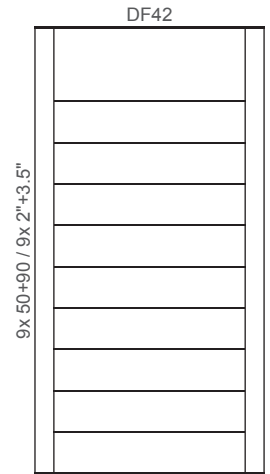
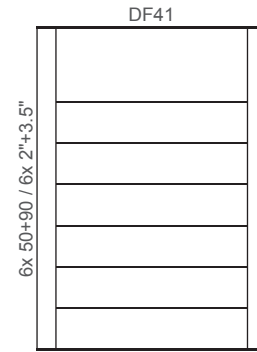
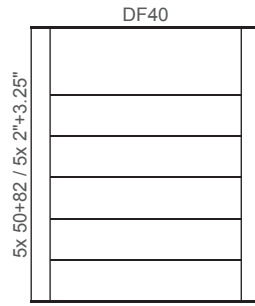
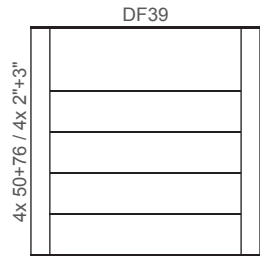
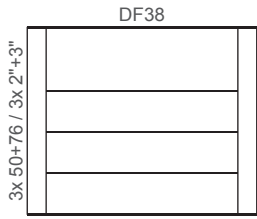
DF-P



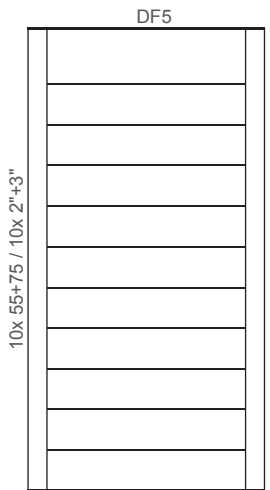
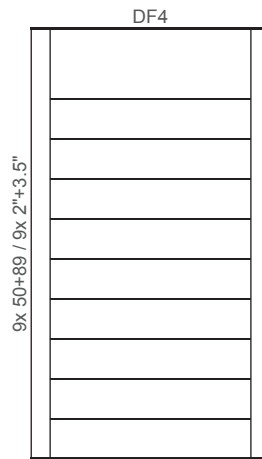
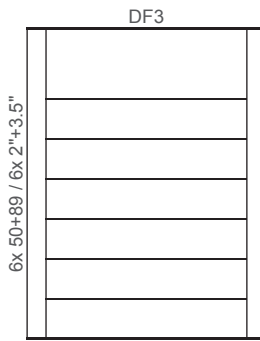
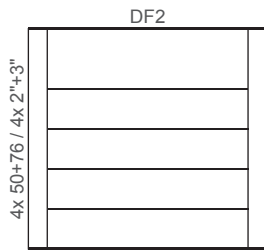
DF (Multy Panel)



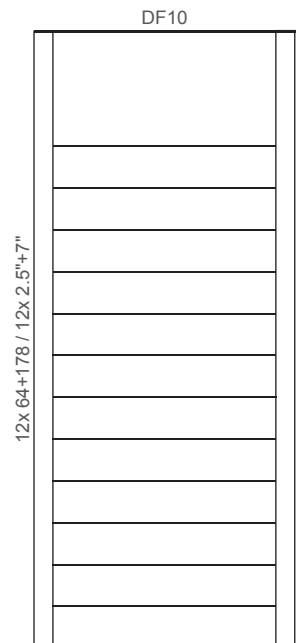
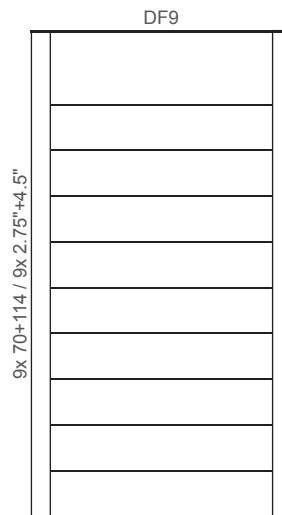
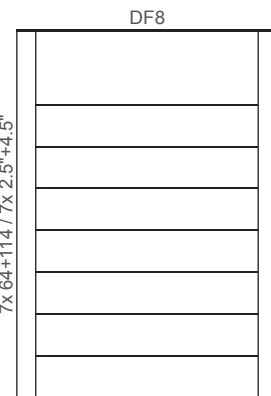
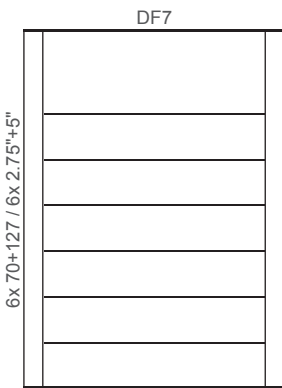
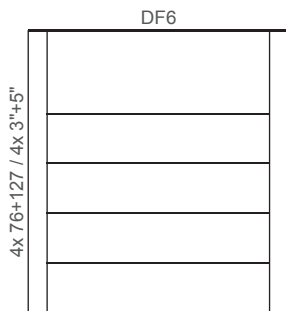
F11 ③④⑧⑨



F300 ③④⑧⑨



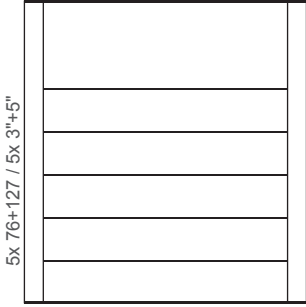
F400 ⑥⑦⑧⑨



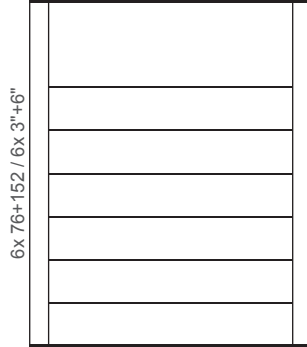
① Please consult the graphic implementation legend on page 2.

F500 ⑥ ⑦ ⑧ ⑩

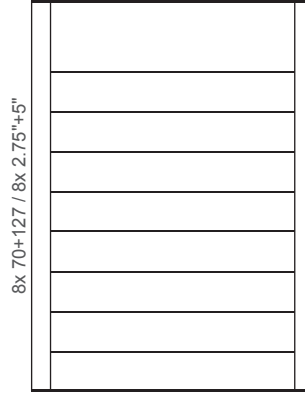
DF11



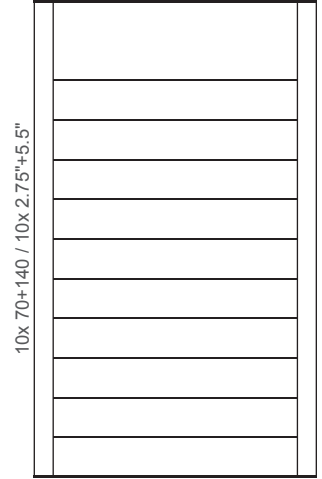
DF12



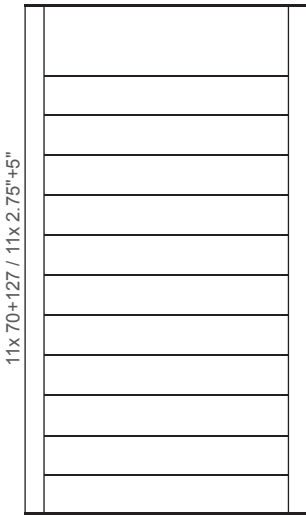
DF13



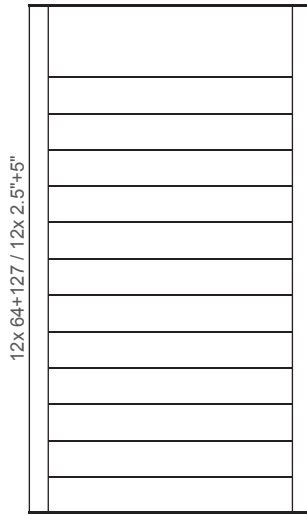
DF14



DF15

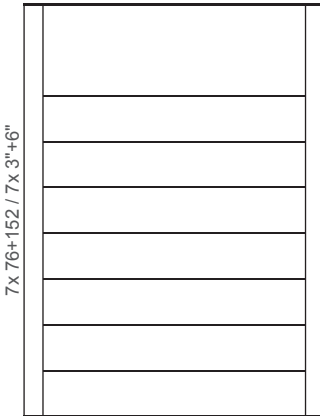


DF16

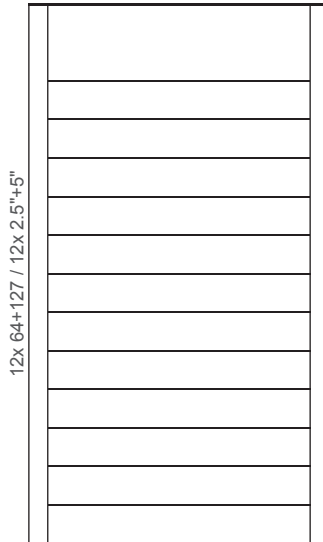


F600 ⑥ ⑦ ⑧ ⑩

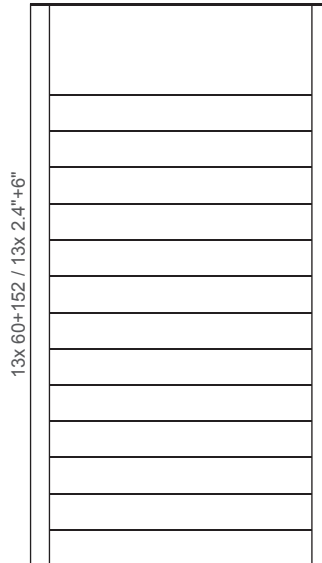
DF17



DF19



DF20

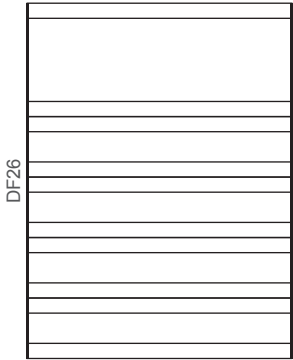


① Please consult the graphic implementation legend on page 2.

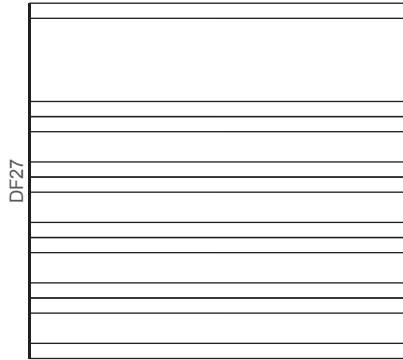
F150 + F80

Title: ③ ④ ⑧ ⑨
Panels: ① ② ⑧ ⑨

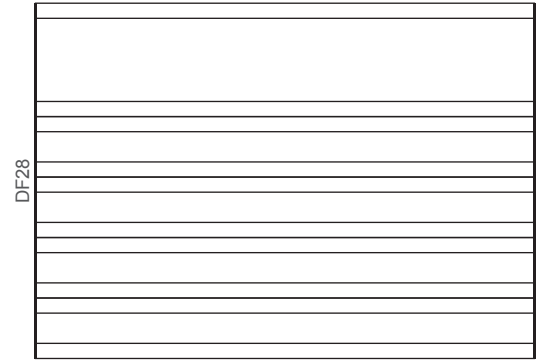
350 / 14"



500 / 20"



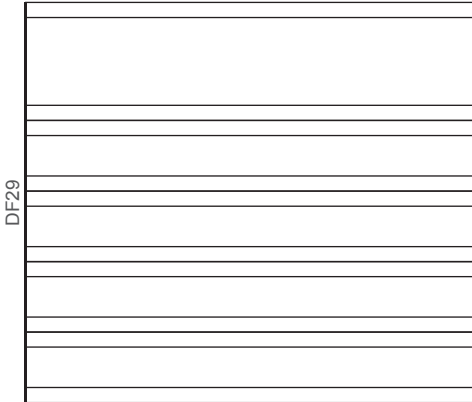
660 / 26"



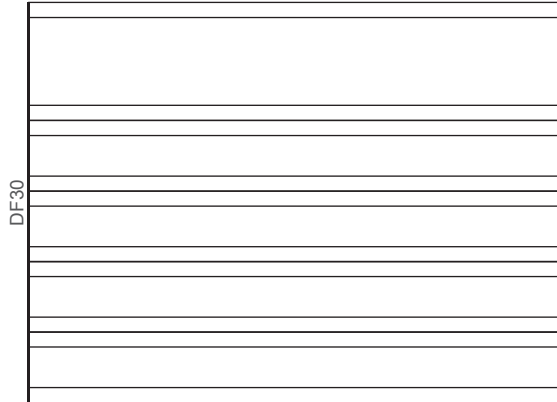
F200 + F120

③ ④ ⑧ ⑨

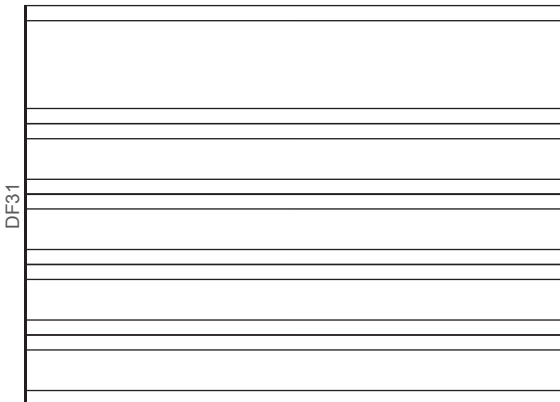
760 / 30"



910 / 36"



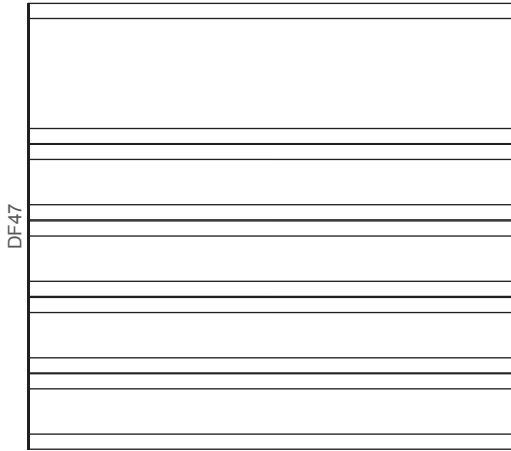
910 / 36"



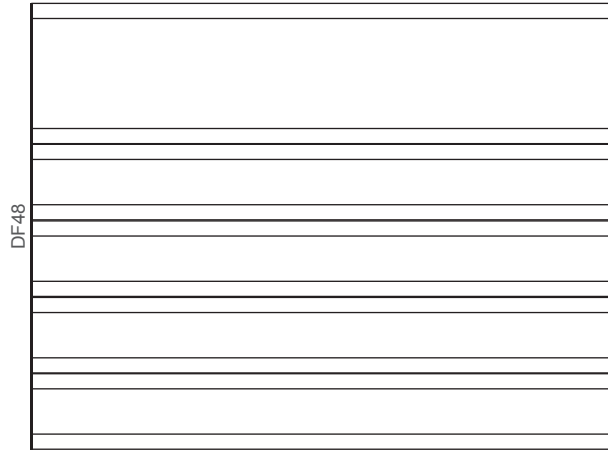
① Please consult the graphic implementation legend on page 2.

F-Letter + F120 ③④⑧⑨

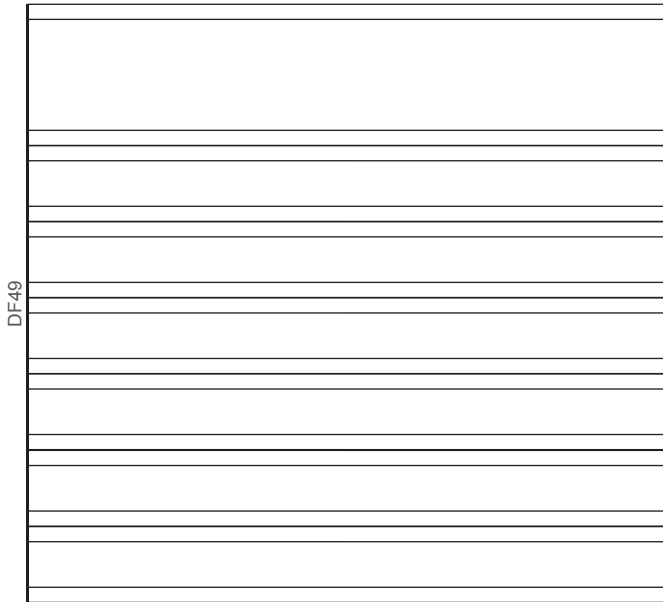
760 / 30"



910 / 36"



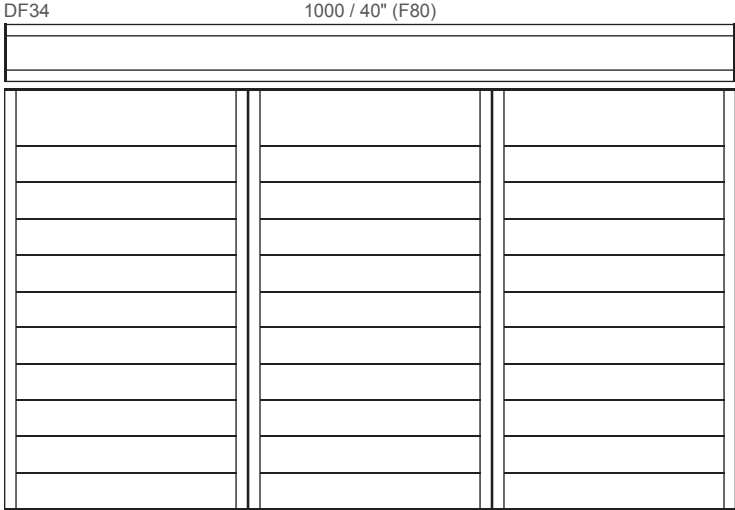
1000 / 40"



① Please consult the graphic implementation legend on page 2.

F80 + 3x F300

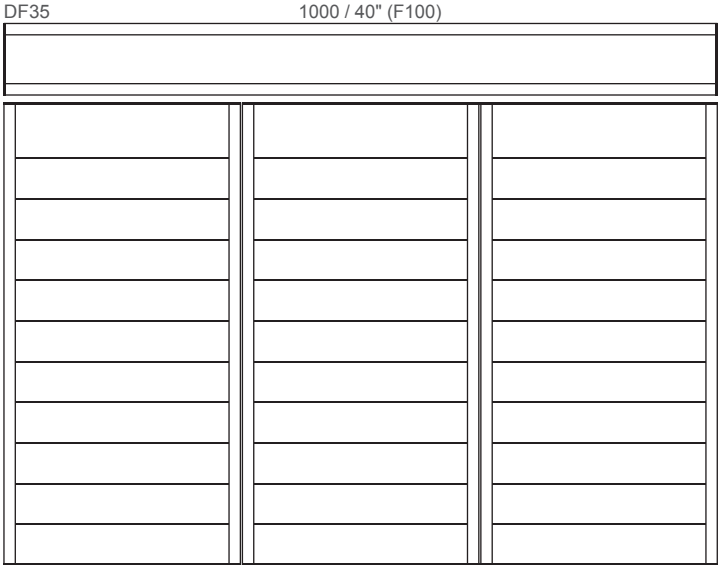
Title: ① ② ⑧ ⑨
Panels: ③ ④ ⑧ ⑨



10x 50+76 / 10x 2"+3" (3x F300)

F100 + 3x F300

Title: ① ② ⑧ ⑨
Panels: ③ ④ ⑧ ⑨

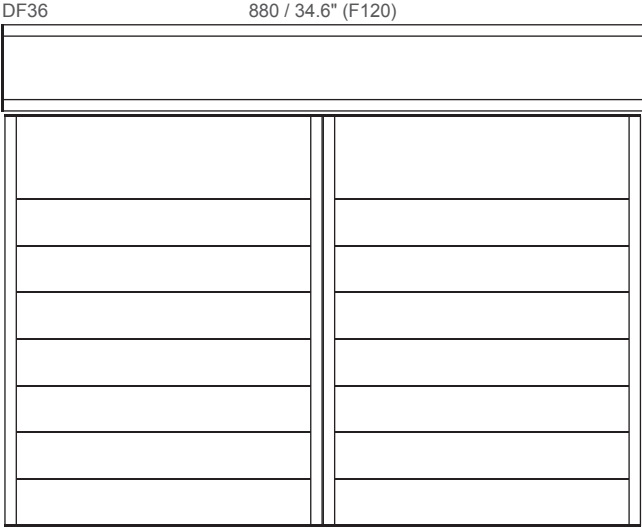


10x 55+75 / 10x 2"+3" (x3 F300)

① Please consult the graphic implementation legend on page 2.

F120 + 2x F400

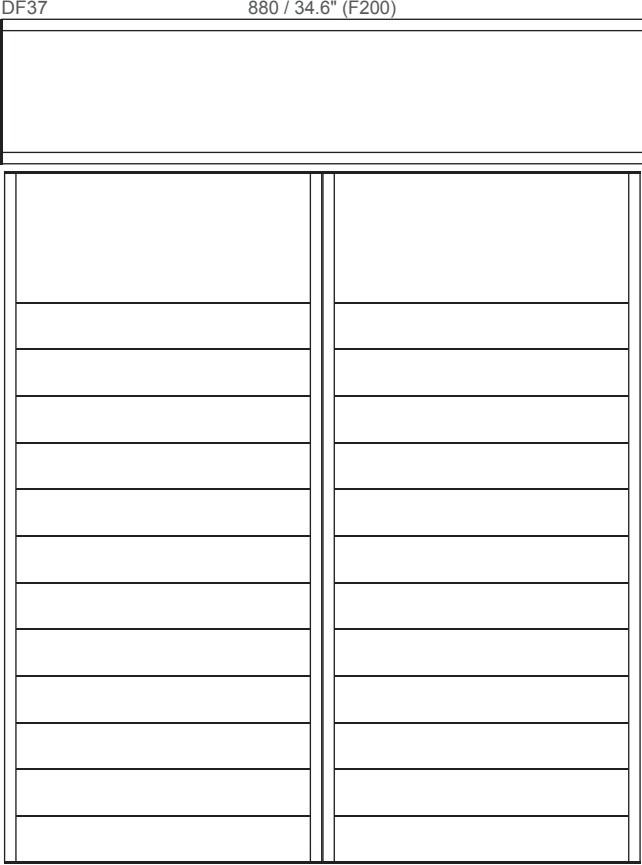
Title: ④ ⑦ ⑧ ⑨
Panels: ⑥ ⑦ ⑧ ⑨



7x 64+114 / 7x 2.5"+4.5" (2x F400)

F200 + 2x F400

Title: ④ ⑦ ⑧ ⑨
Panels: ⑥ ⑦ ⑧ ⑨



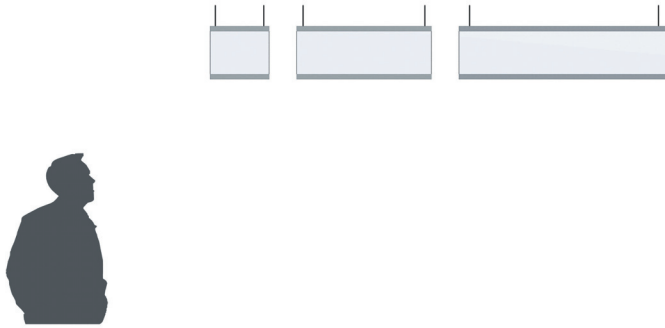
12x 64+178 / 12x 2.5"+7" (2x F400)

① Please consult the graphic implementation legend on page 2.

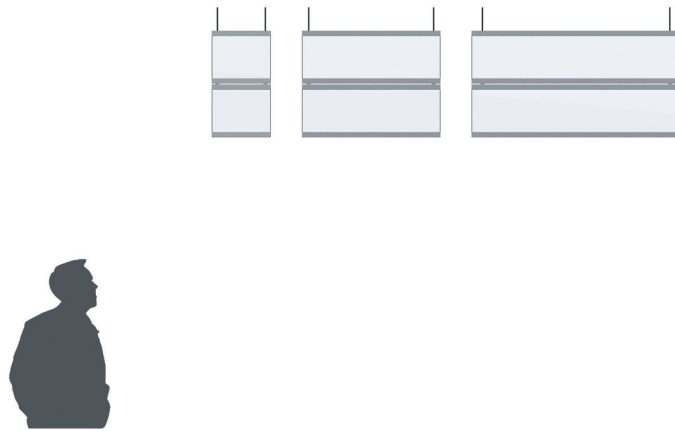


Suspended signs are mostly applied as hallway wayfinding signs and long lasting promotional signs (seeing as how updating them at such heights frequently is not very efficient). Suspended signs can be designed to meet your specific measurement requirements.

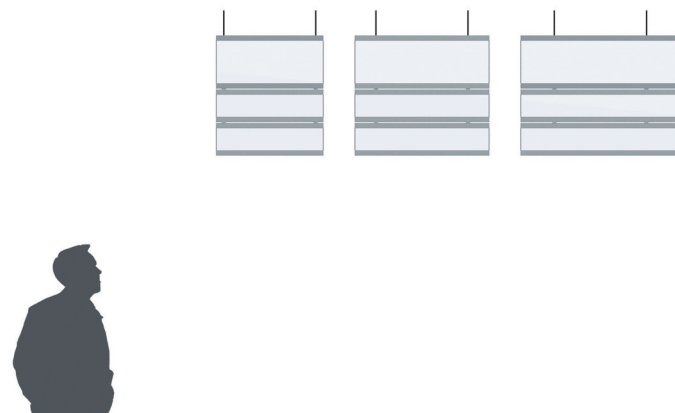
SUSF-Letter



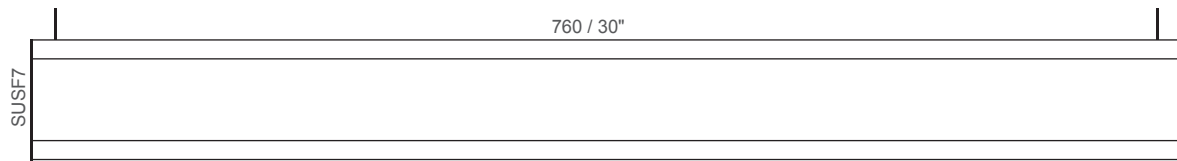
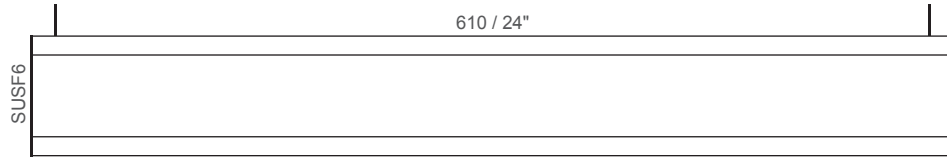
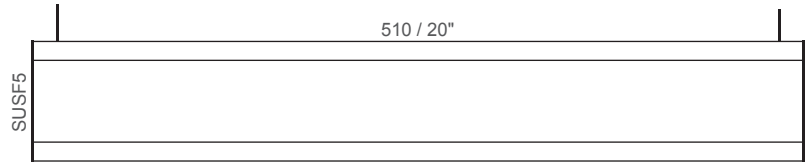
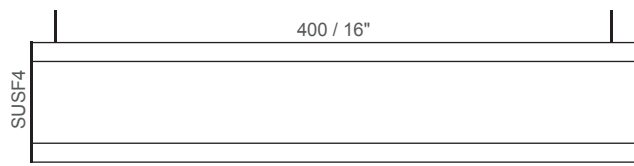
SUSF-Letterx2



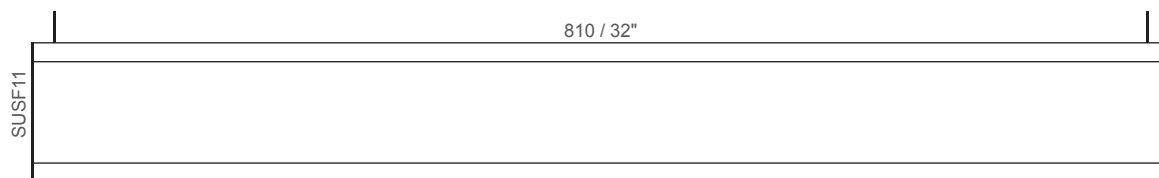
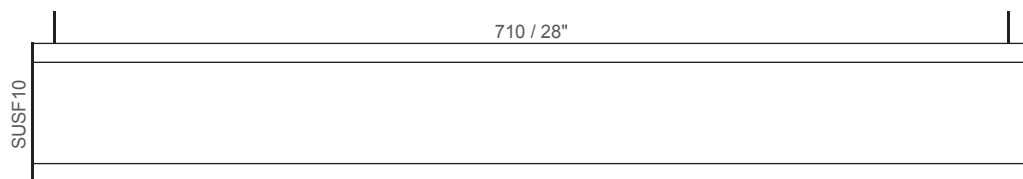
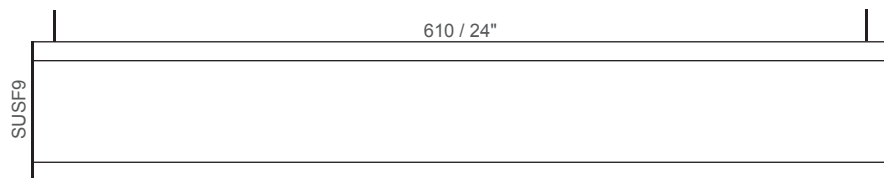
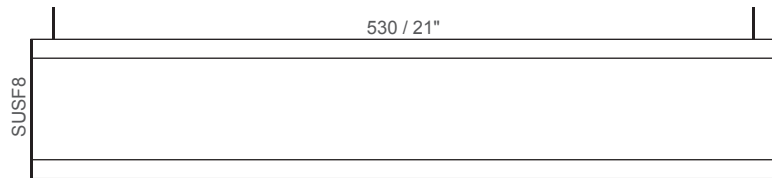
SUSF-Letter & F120x2



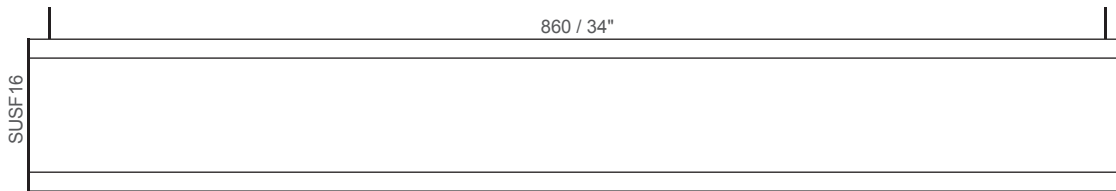
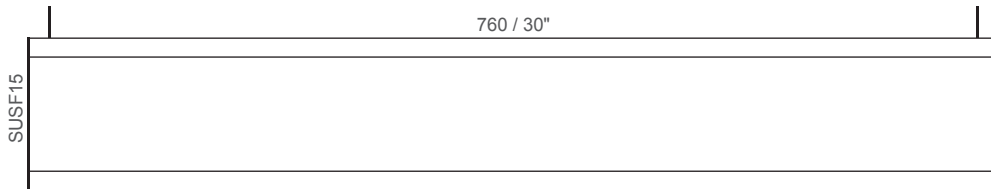
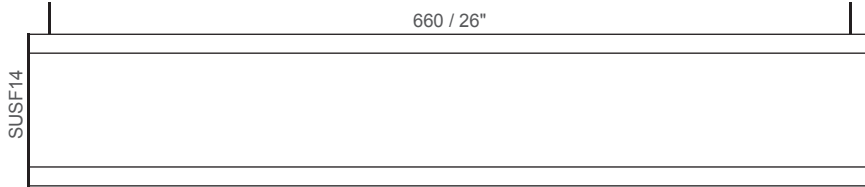
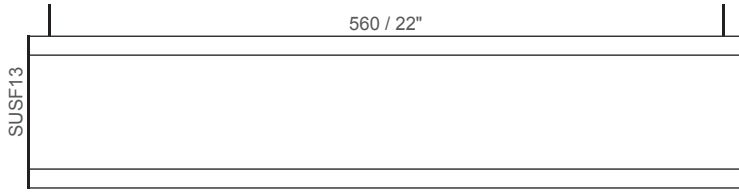
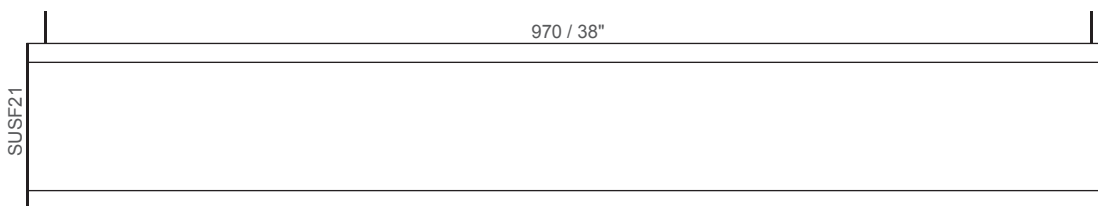
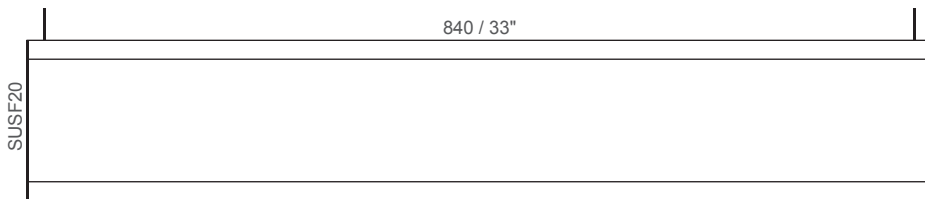
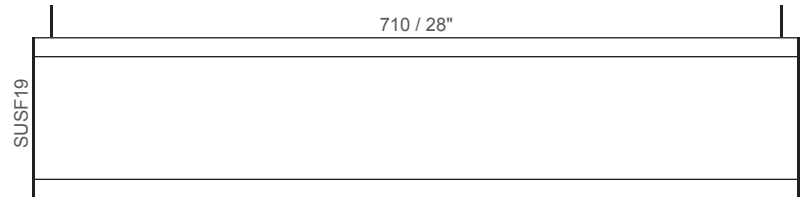
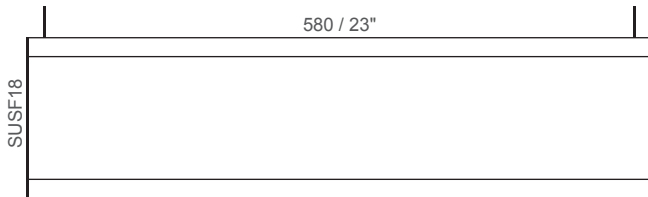
F80 ①②⑧⑨



F100 ①②⑧⑨

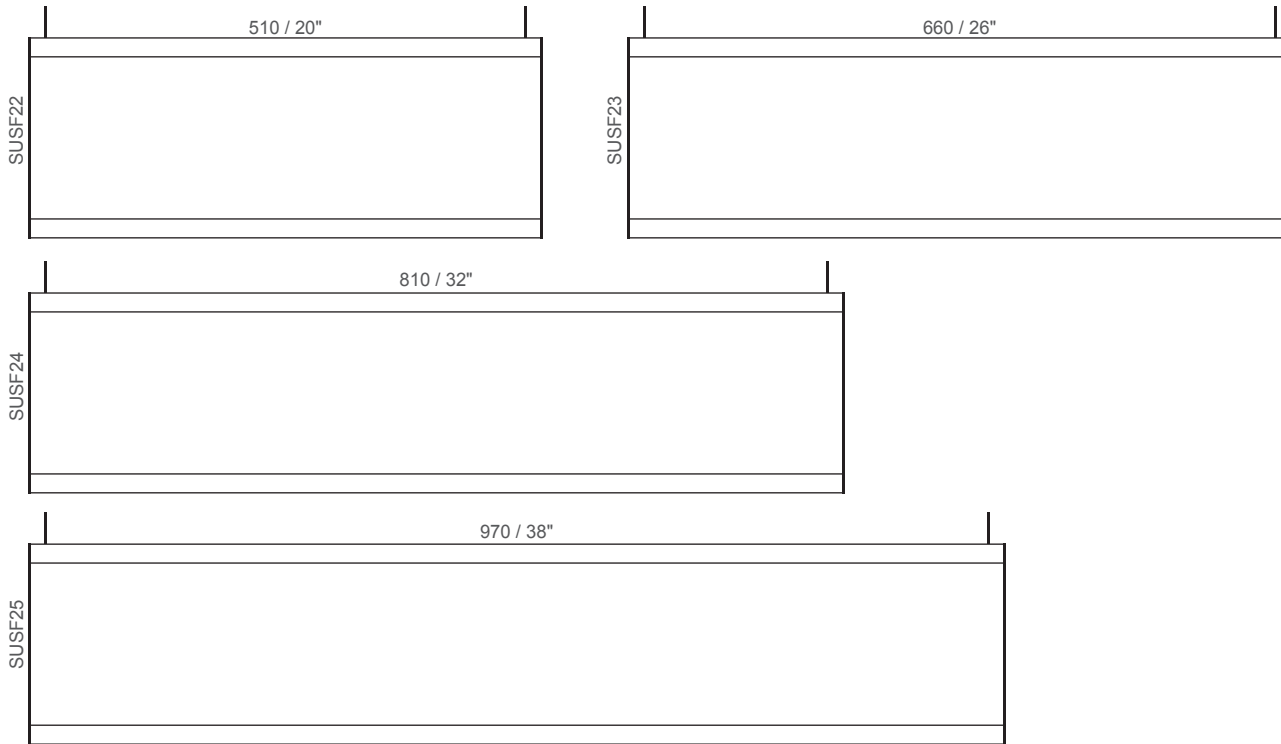


① Please consult the graphic implementation legend on page 2.

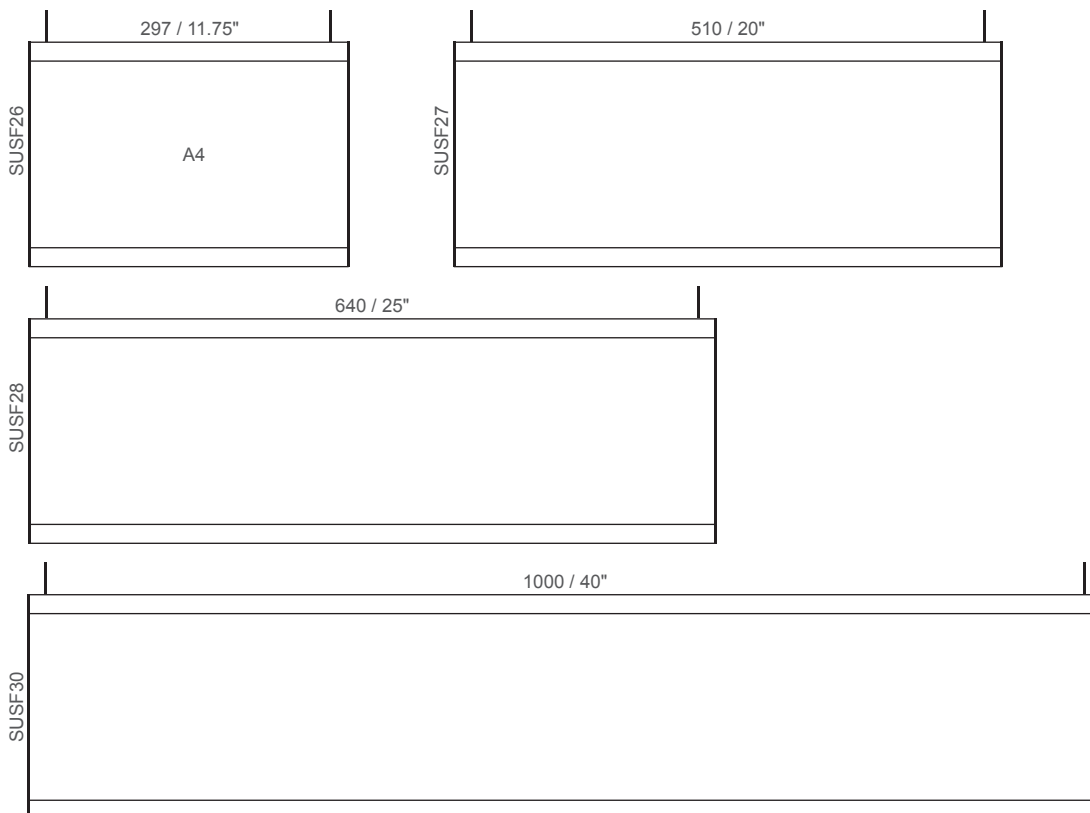
F120 ③④⑧⑨**F150** ③④⑧⑨

① Please consult the graphic implementation legend on page 2.

F200 ③④⑧⑨

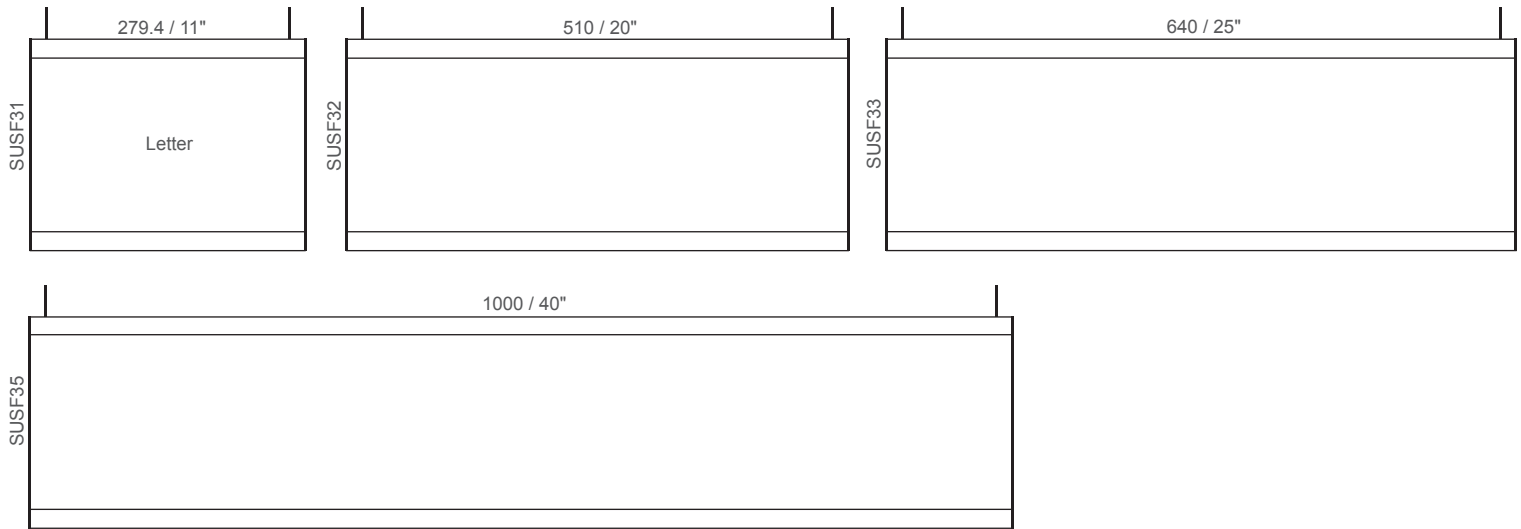


F-A4 ③④⑧⑨

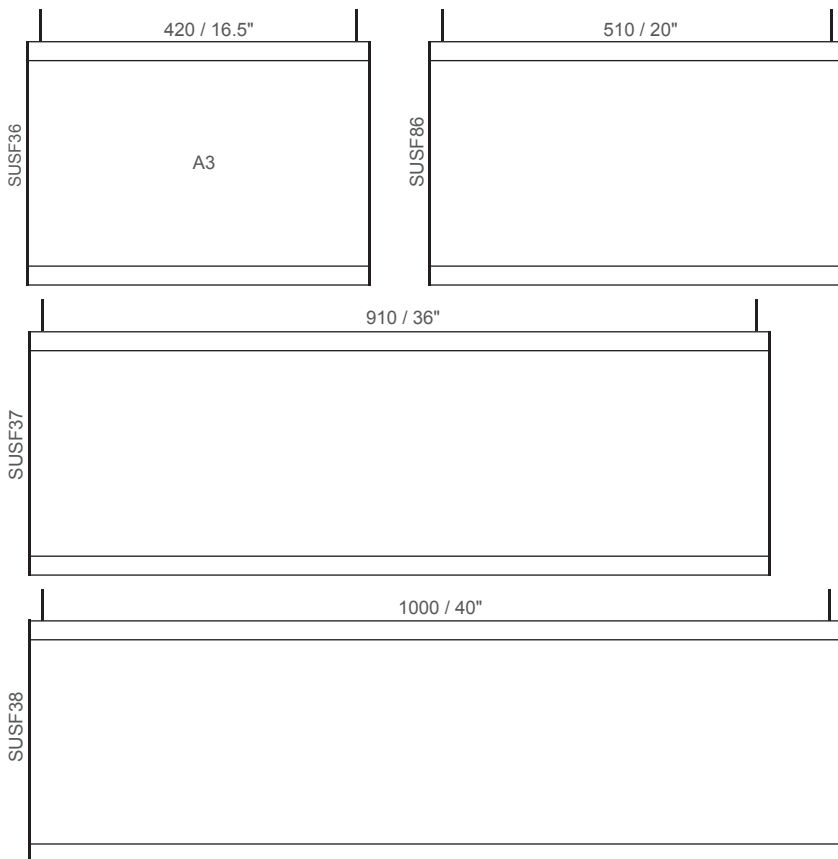


ⓘ Please consult the graphic implementation legend on page 2.

F-Letter ③④⑧⑨

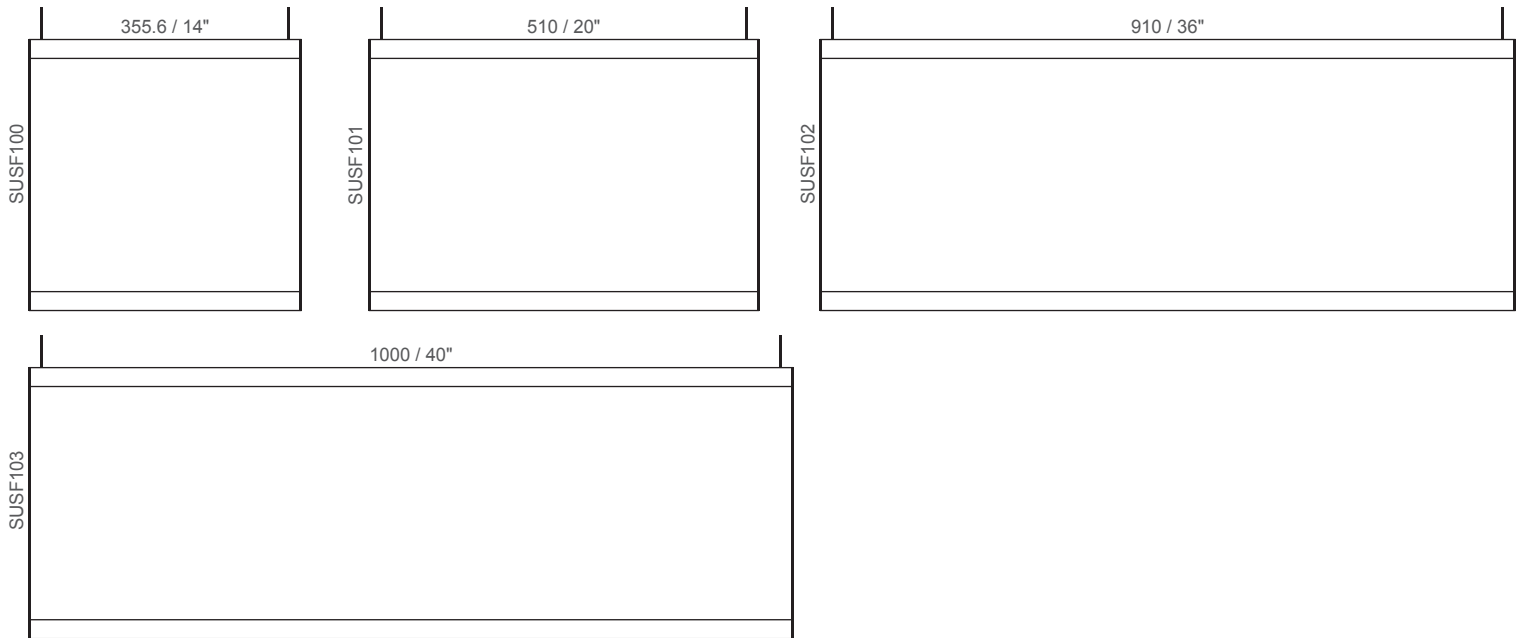


F300 ③④⑧⑨

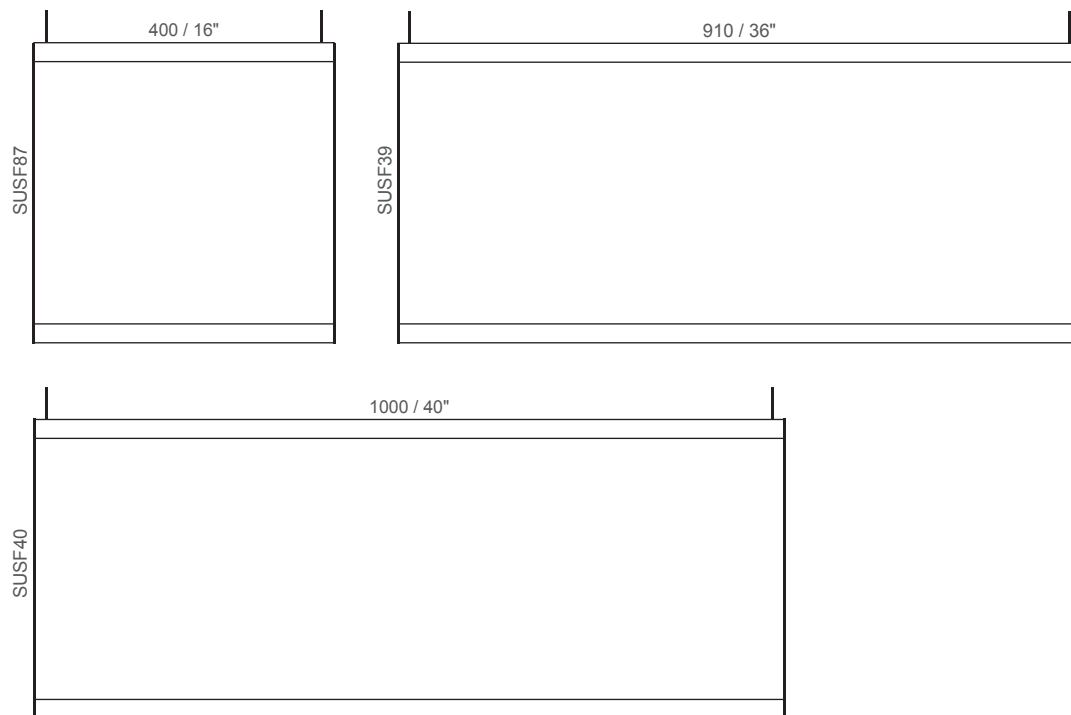


ⓘ Please consult the graphic implementation legend on page 2.

F14 ③④⑧⑨

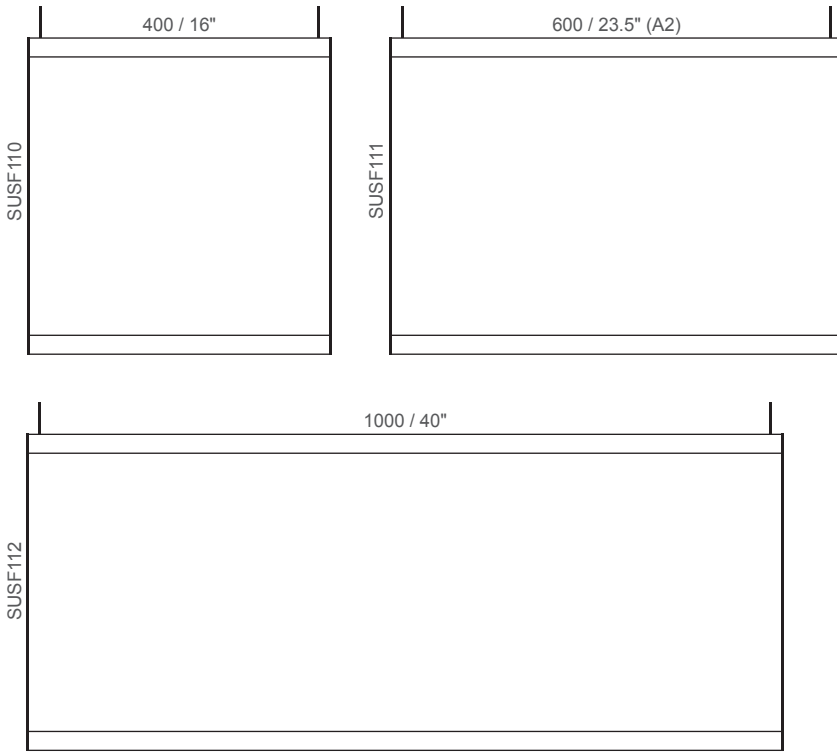


F400 ⑤⑥⑧⑨

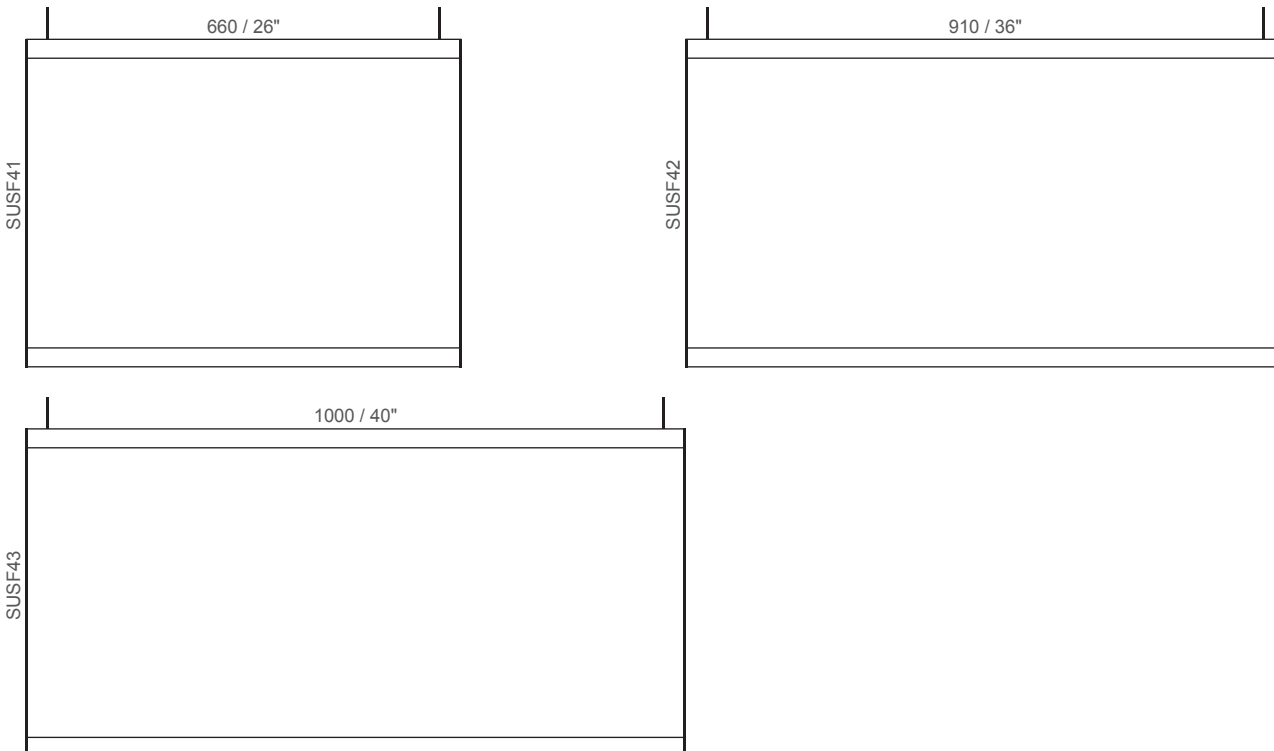


① Please consult the graphic implementation legend on page 2.

F420 ⑤⑥⑧⑨

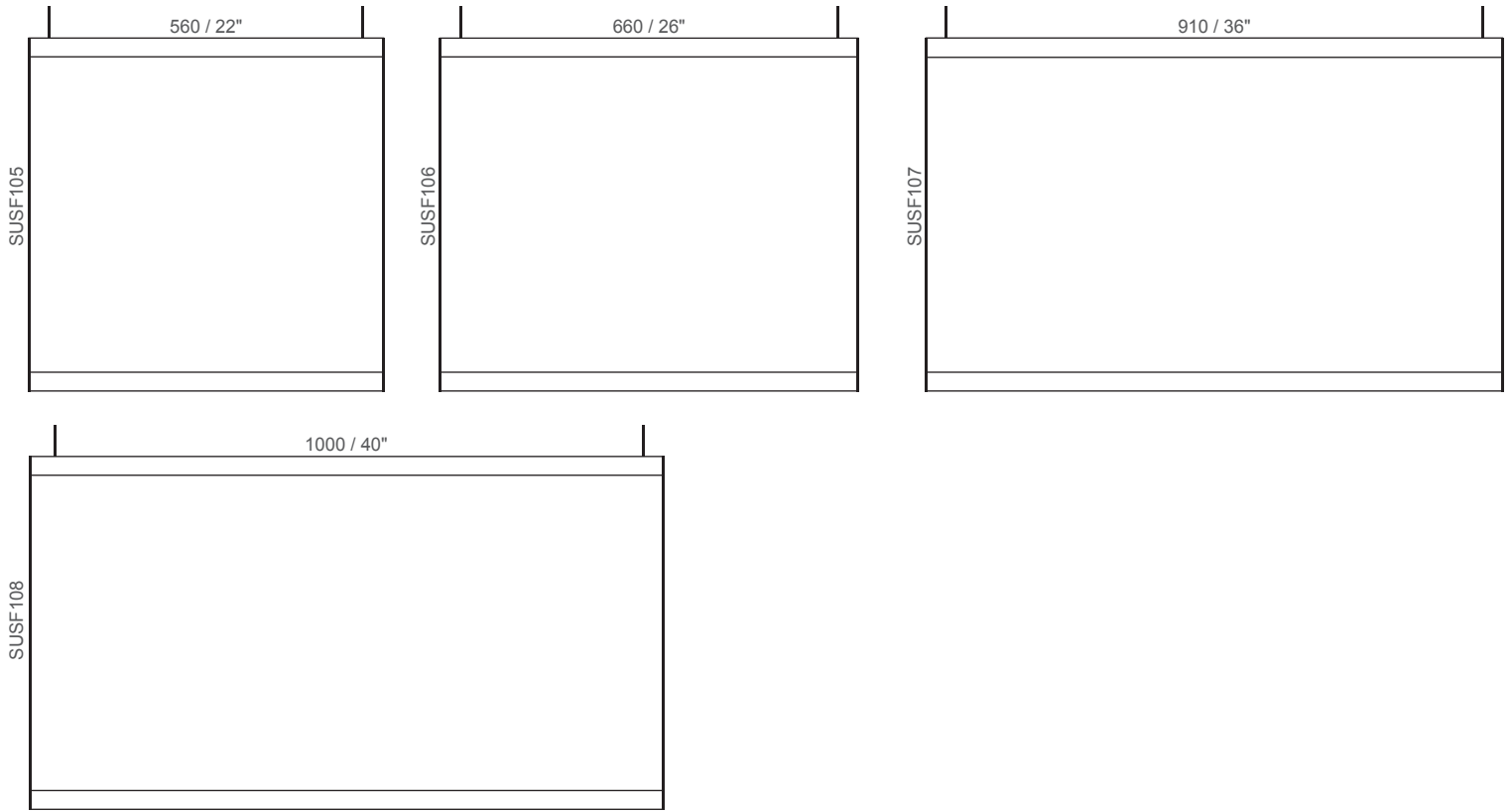


F500 ⑤⑥⑧⑩

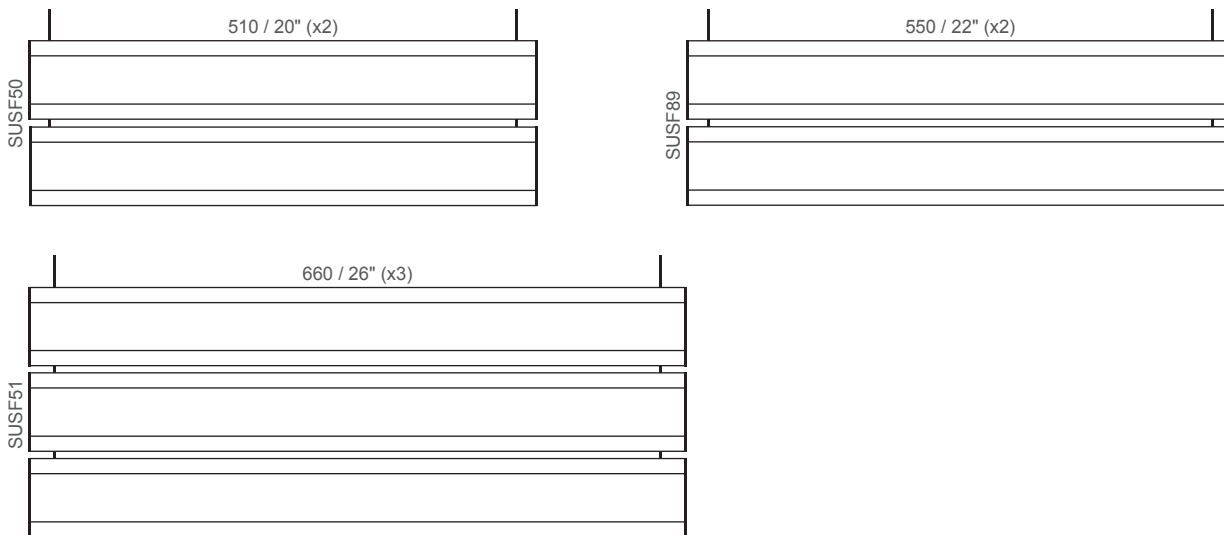


① Please consult the graphic implementation legend on page 2.

F22 ⑤⑥⑧⑩

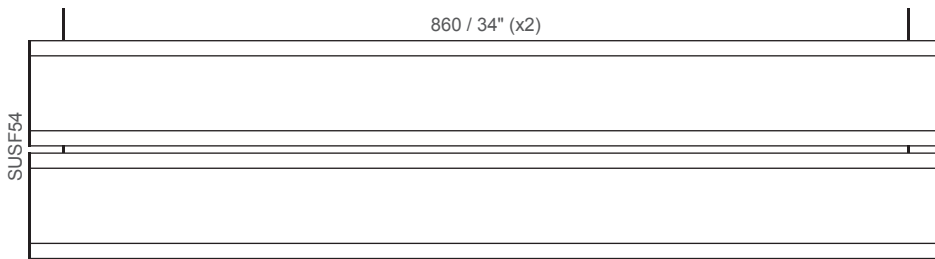
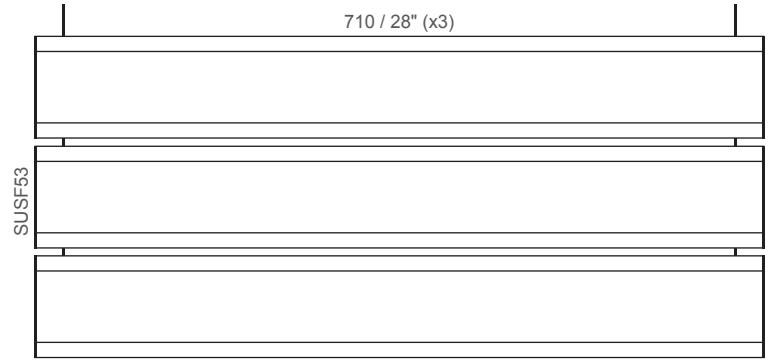
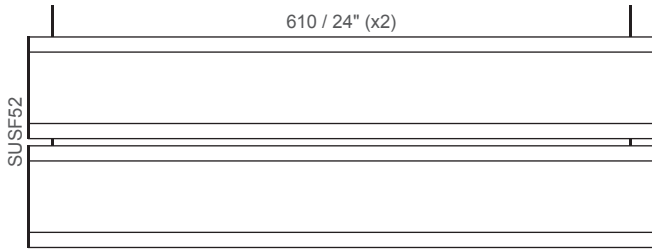


F80 ①②⑧⑨

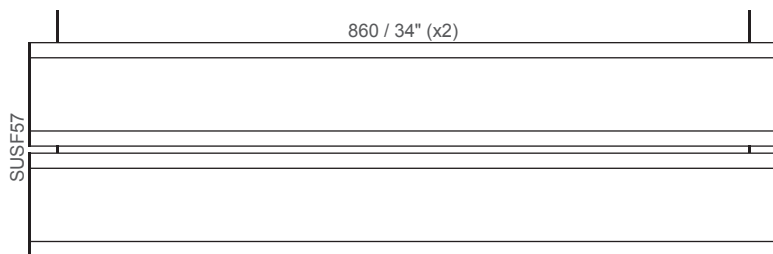
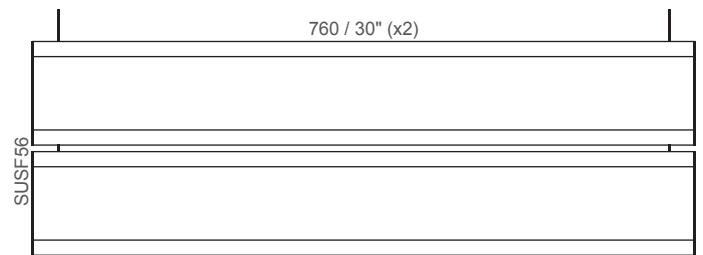
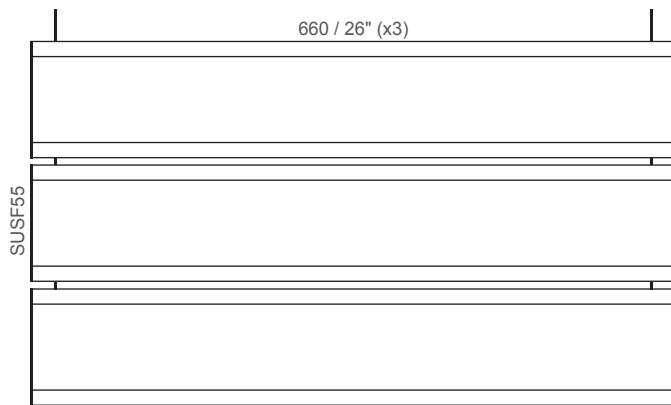


① Please consult the graphic implementation legend on page 2.

F100 ①②⑧⑨

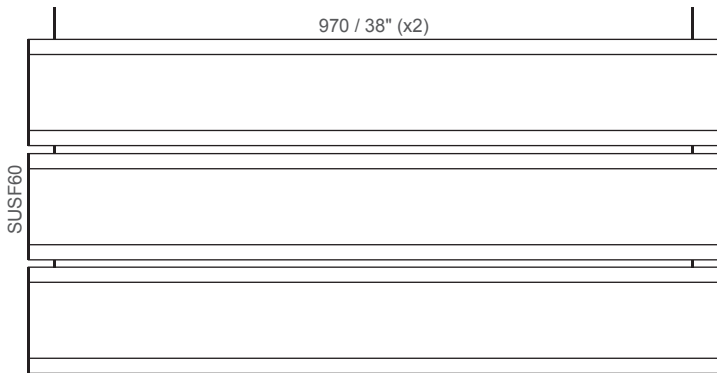
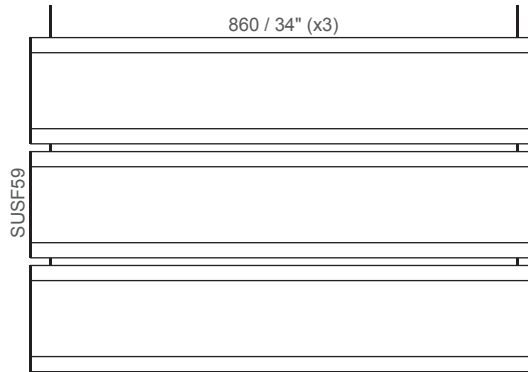
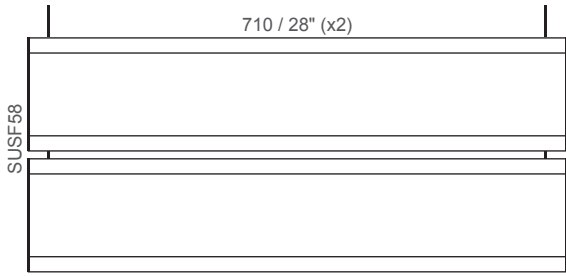


F120 ③④⑧⑨

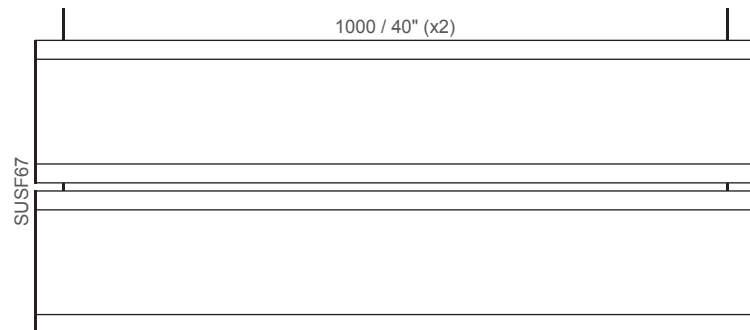
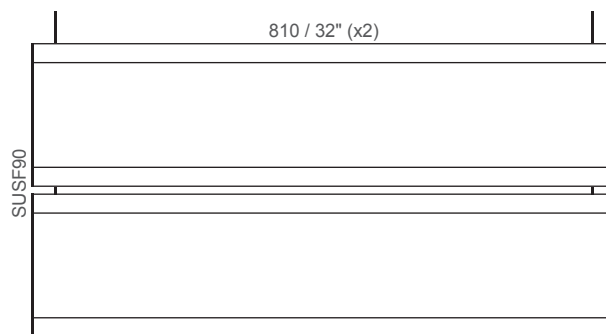
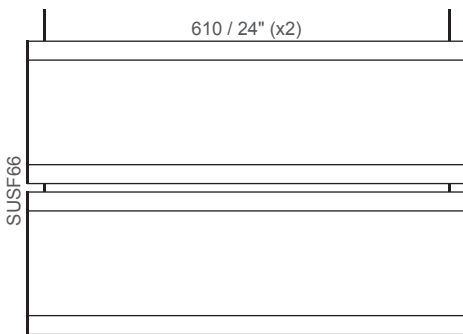


① Please consult the graphic implementation legend on page 2.

F150 ③④⑧⑨

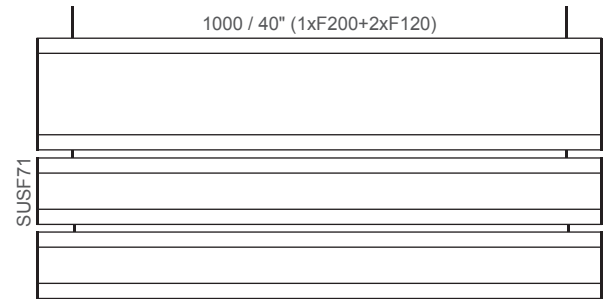
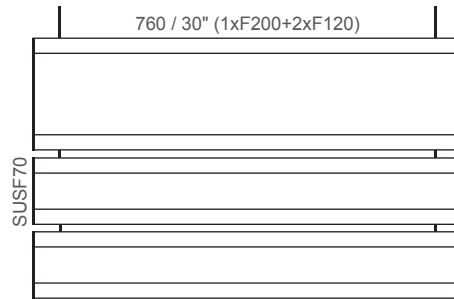
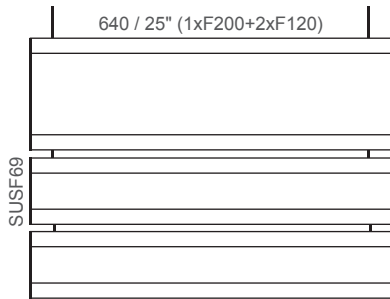


F200 ③④⑧⑨

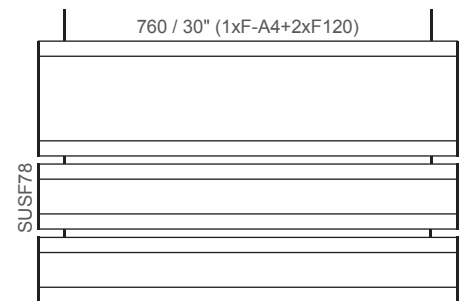
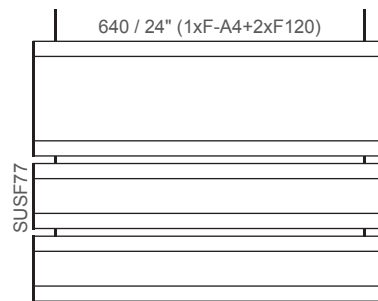
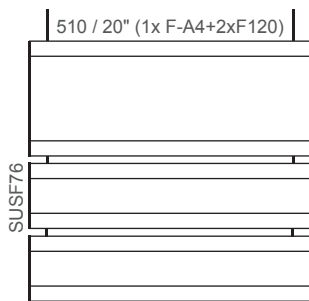


① Please consult the graphic implementation legend on page 2.

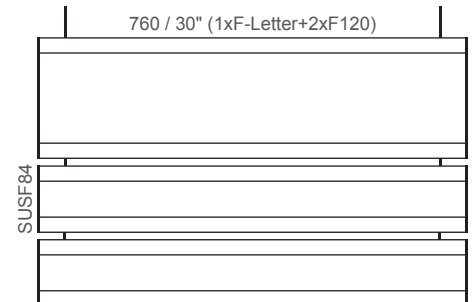
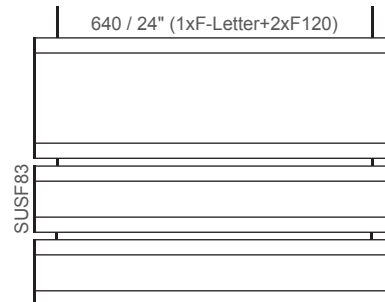
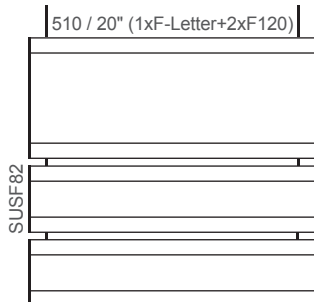
F200 + F120 ③④⑧⑨



F-A4 + F120 ③④⑧⑨



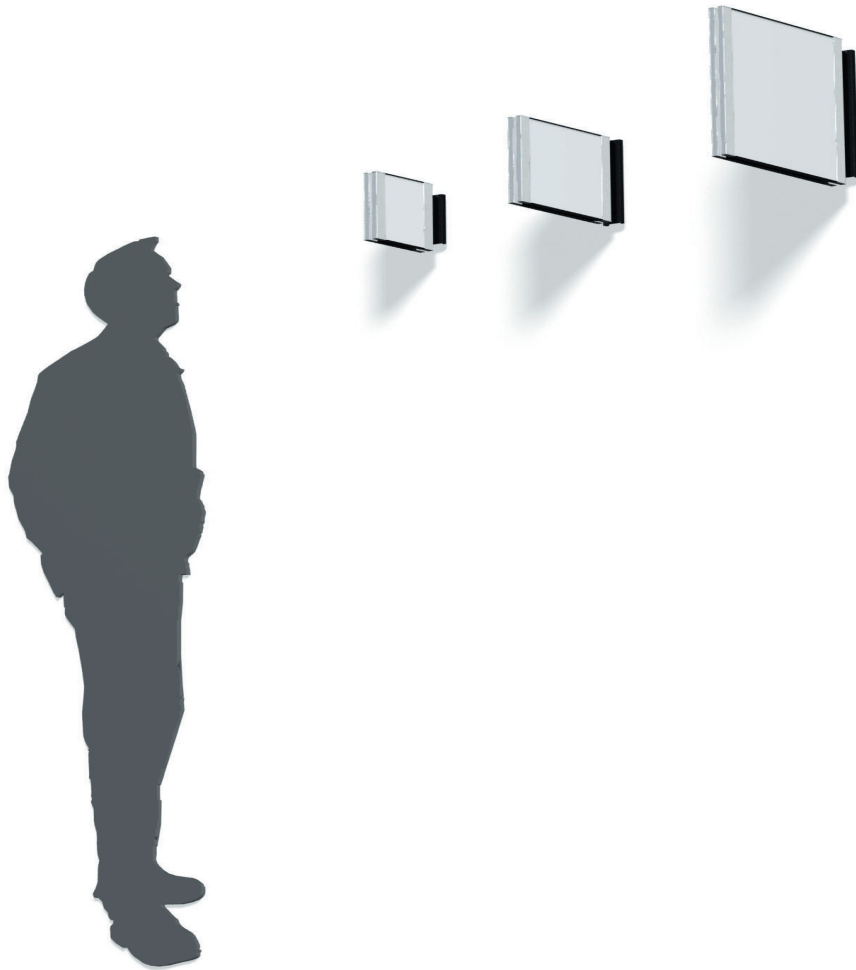
F-Letter + F120 ③④⑧⑨



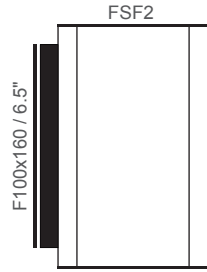
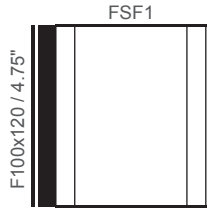
① Please consult the graphic implementation legend on page 2.



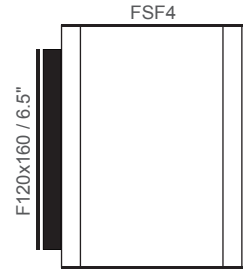
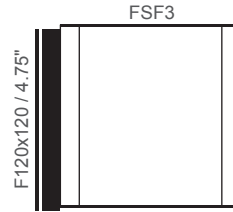
Flag Signs, who are also known as projecting signs, are very good at attracting the public's attention and are most commonly used to identify bathrooms, public areas, meeting areas, security information and a more recent trend is in airports as a lounge indicator.



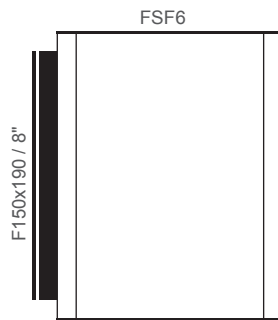
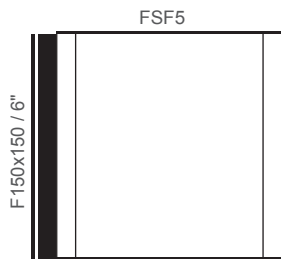
F100 ①②⑧⑨



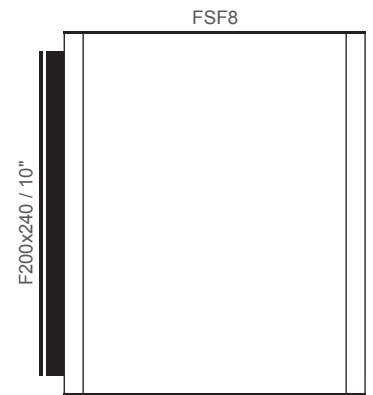
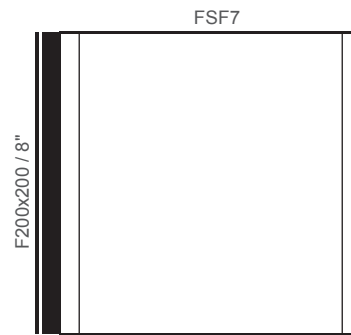
F120 ③④⑧⑨



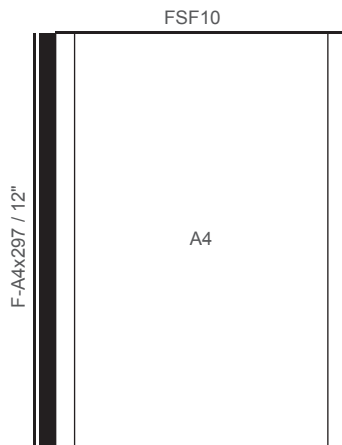
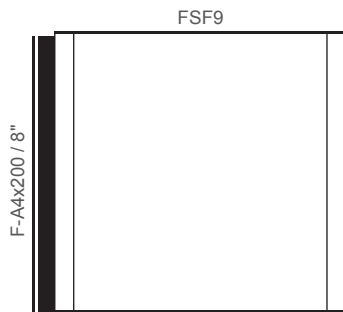
F150 ③④⑧⑨



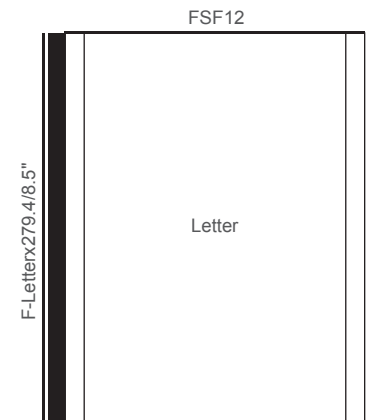
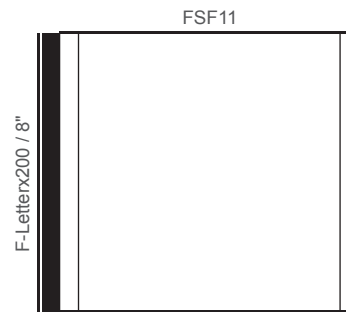
F200 ③④⑧⑨



F-A4 ③④⑧⑨

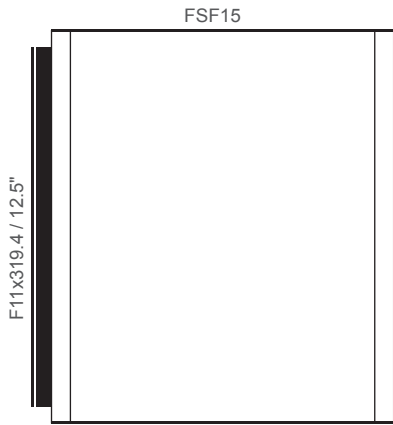


F-Letter ③④⑧⑨

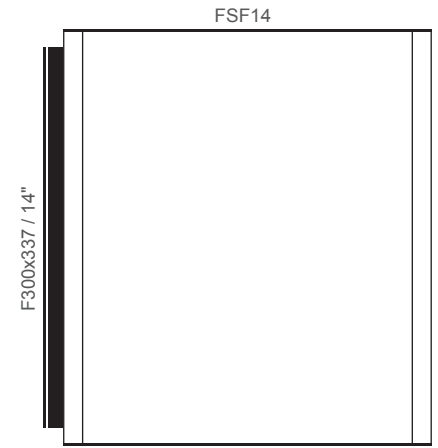
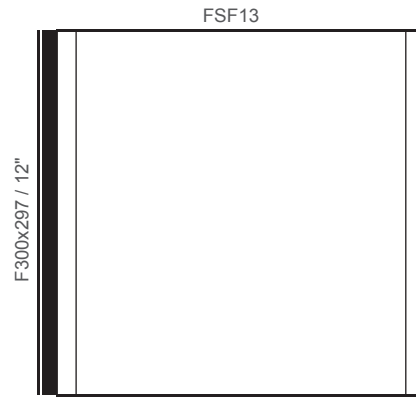


① Please consult the graphic implementation legend on page 2.

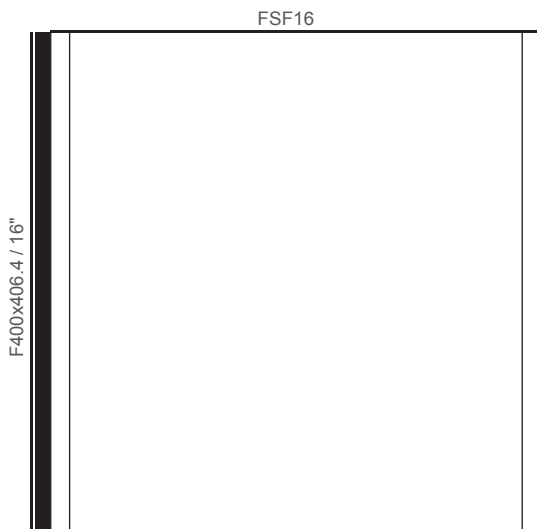
F11 ③④⑧⑨



F300 ③④⑧⑨



F400 ⑤⑥⑧⑨

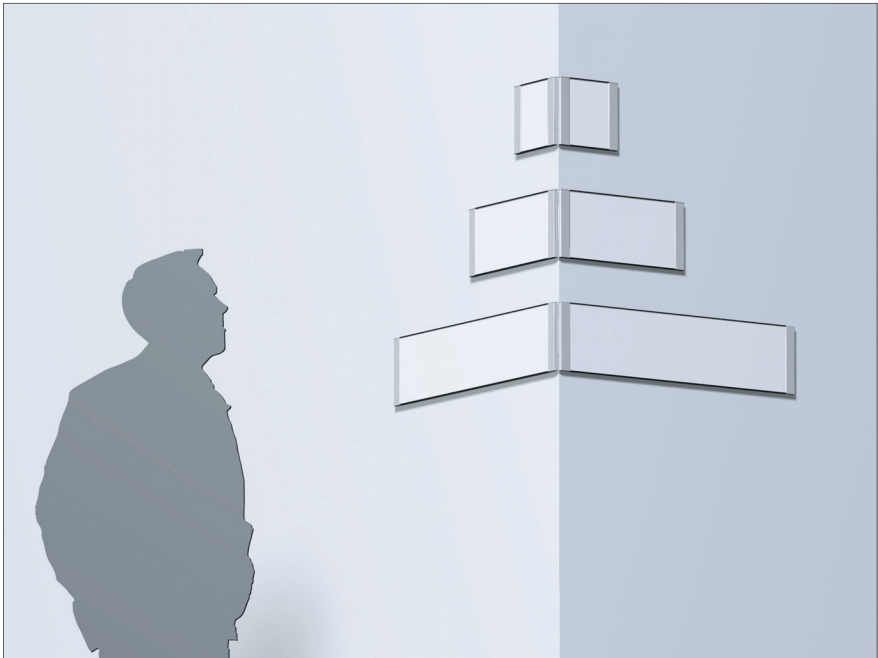


① Please consult the graphic implementation legend on page 2.

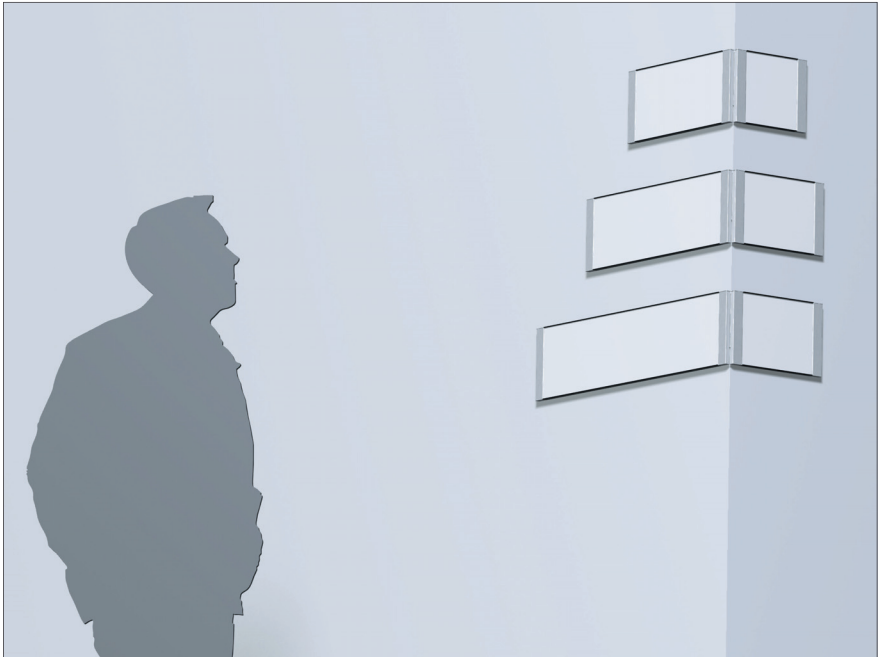


Turn your everyday corners into a design element to complement your overall design. The Corner Signs offer a unique fresh look, are easy to install and offer increased visibility to their content.

COS

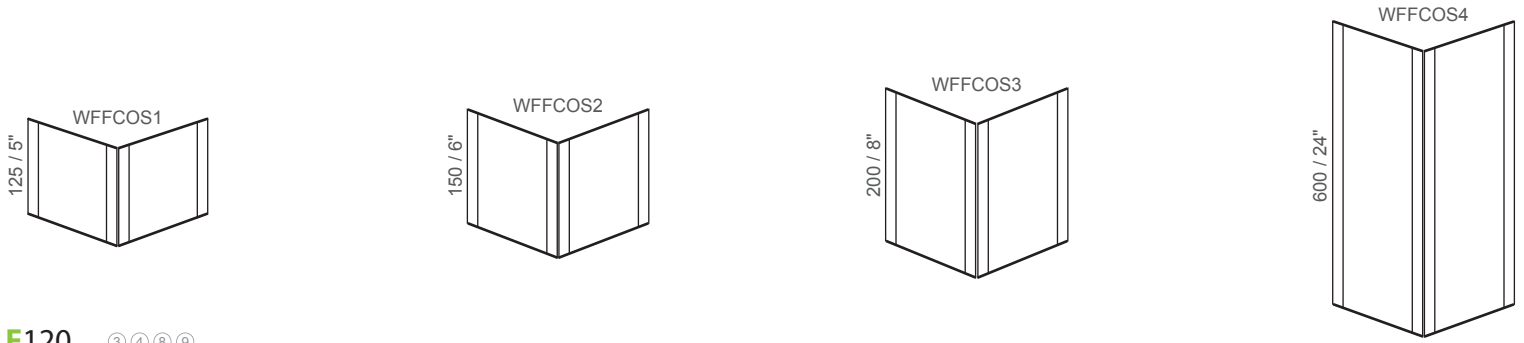


COA

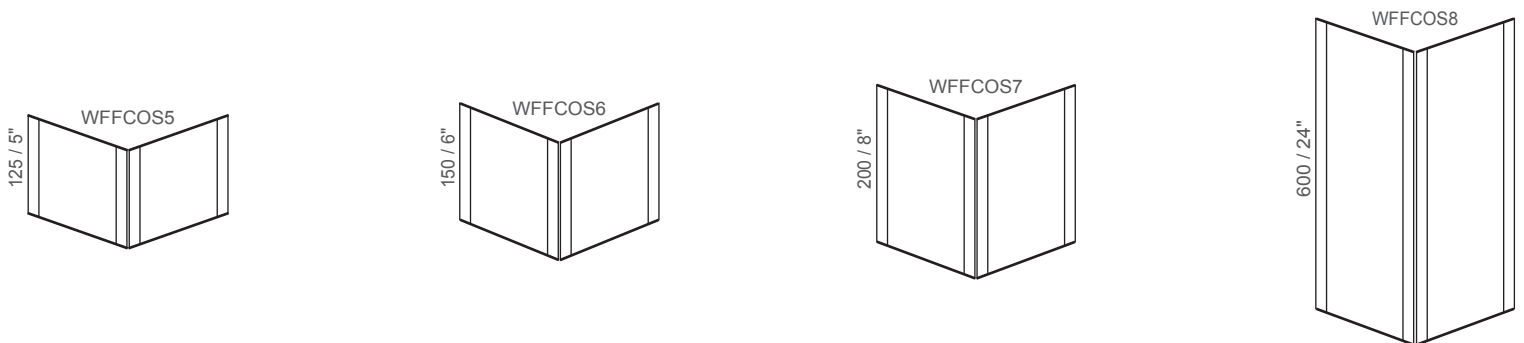


Corner signs come only in floating version

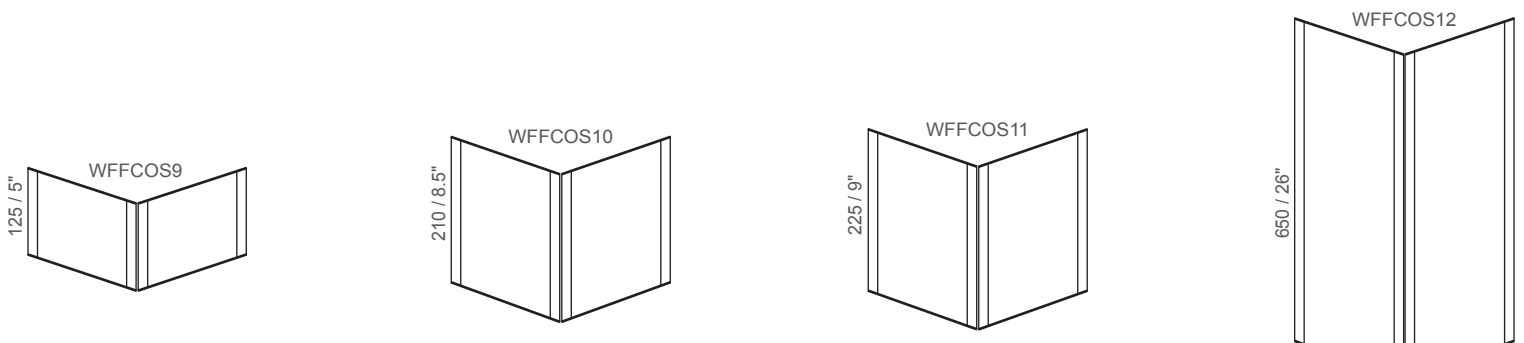
F100 ① ② ⑧ ⑨



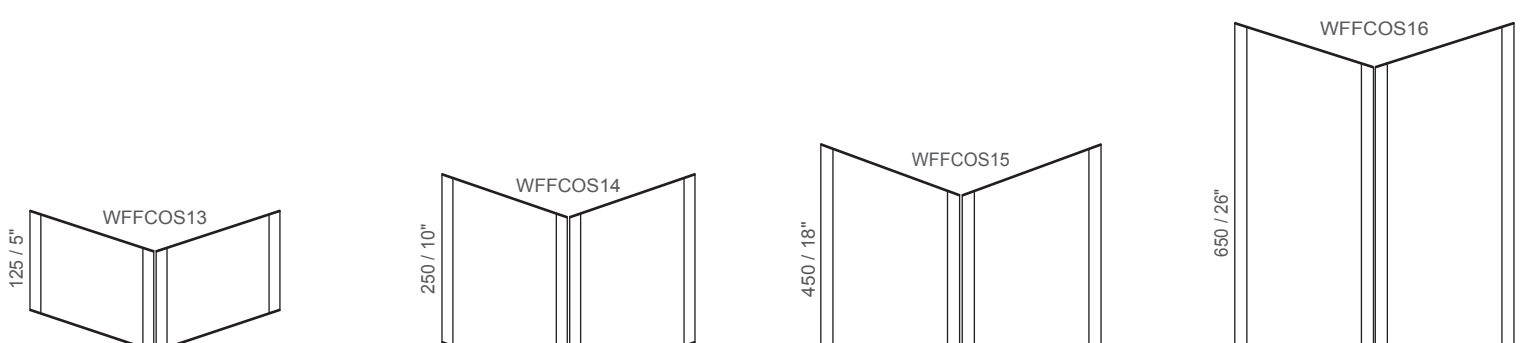
F120 ③ ④ ⑧ ⑨



F150 ③ ④ ⑧ ⑨



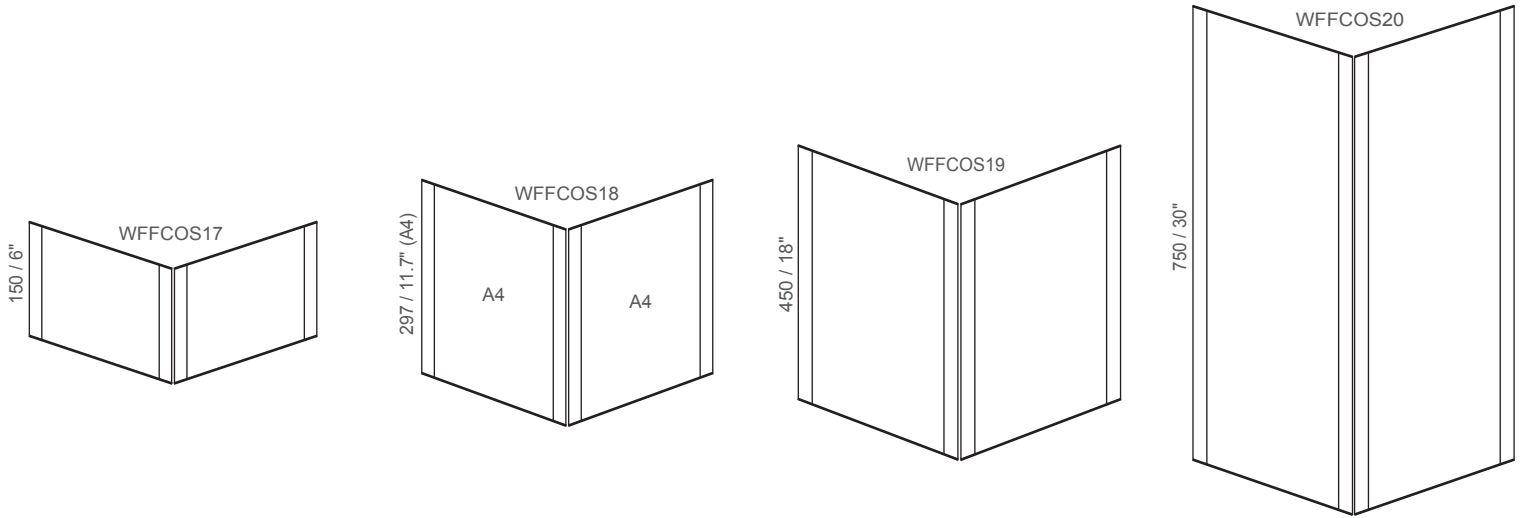
F200 ③ ④ ⑧ ⑨



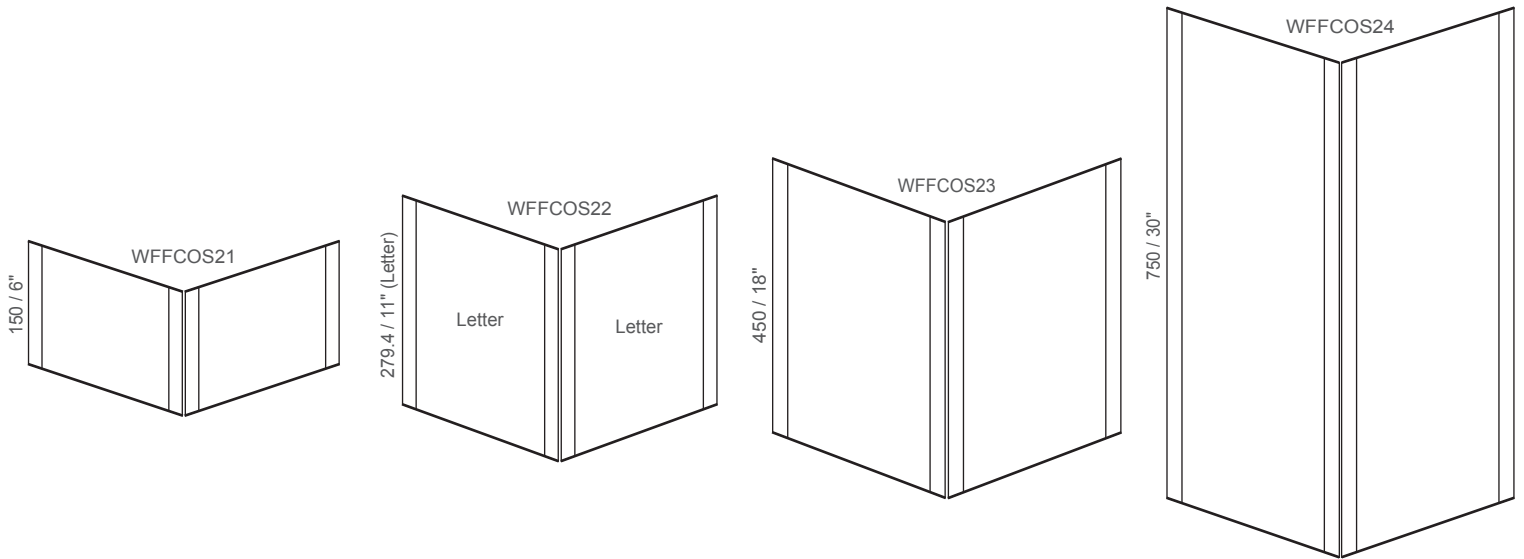
① Please consult the graphic implementation legend on page 2.

Corner signs come only in floating version

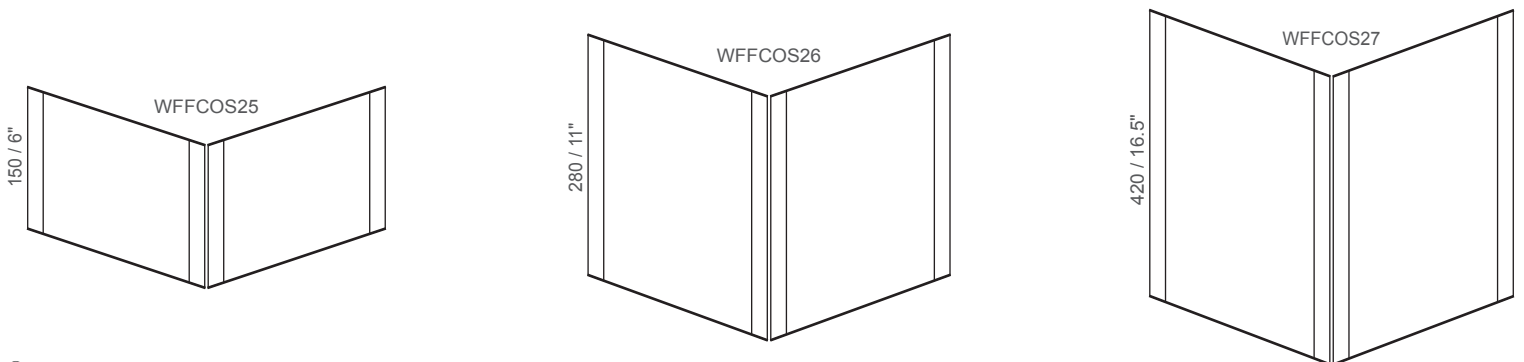
F-A4 ③④⑧⑨



F-Letter ③④⑧⑨



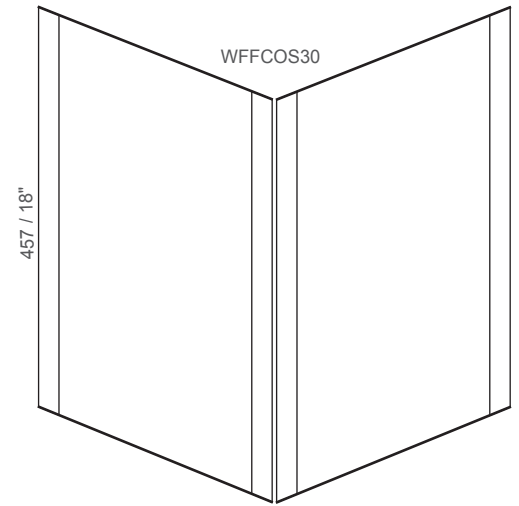
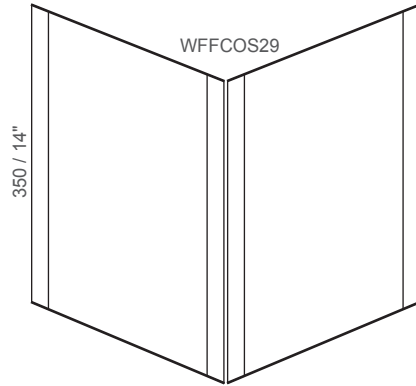
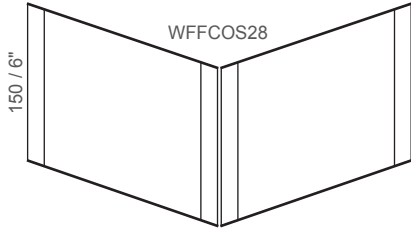
F11 ③④⑧⑨



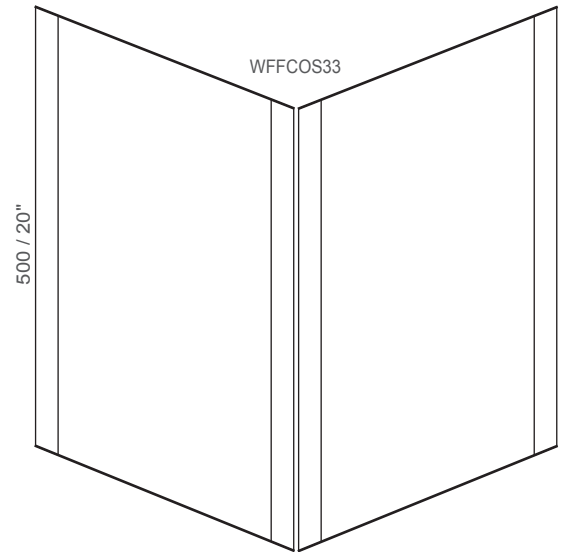
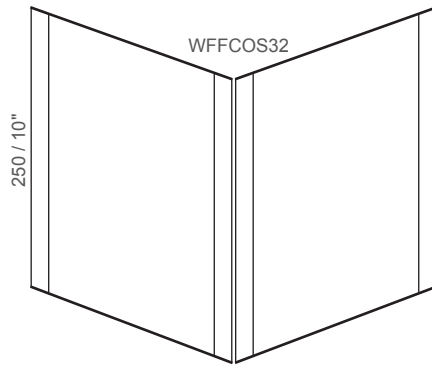
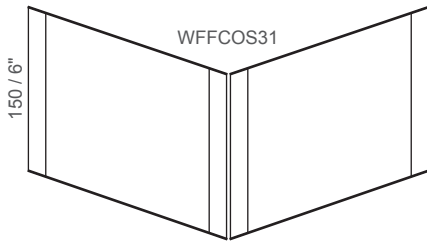
① Please consult the graphic implementation legend on page 2.

Corner signs come only in floating version

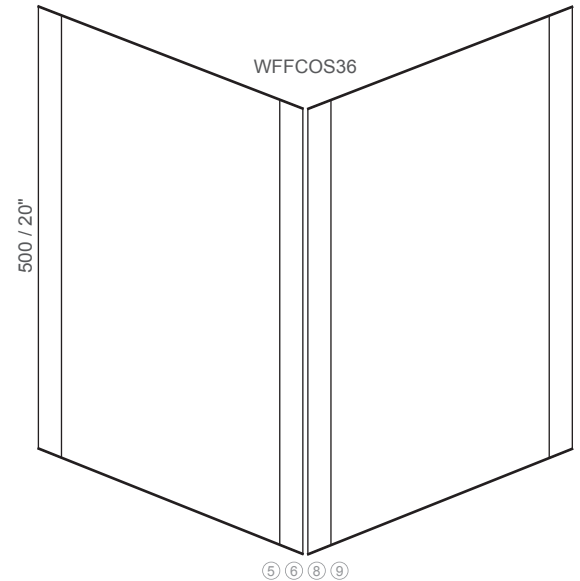
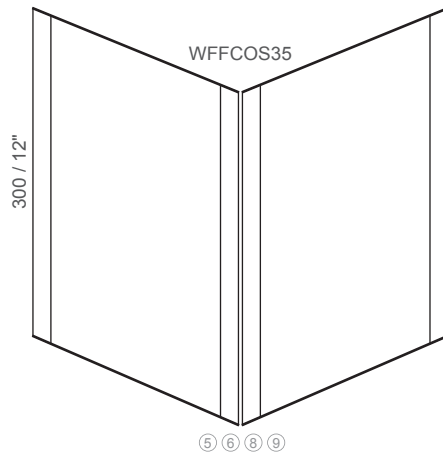
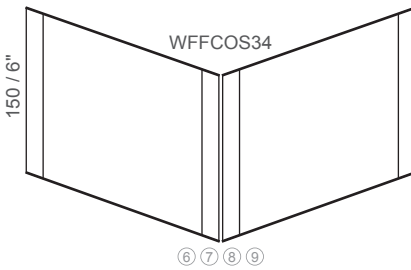
F300 ③ ④ ⑧ ⑨



F14 ③ ④ ⑧ ⑨



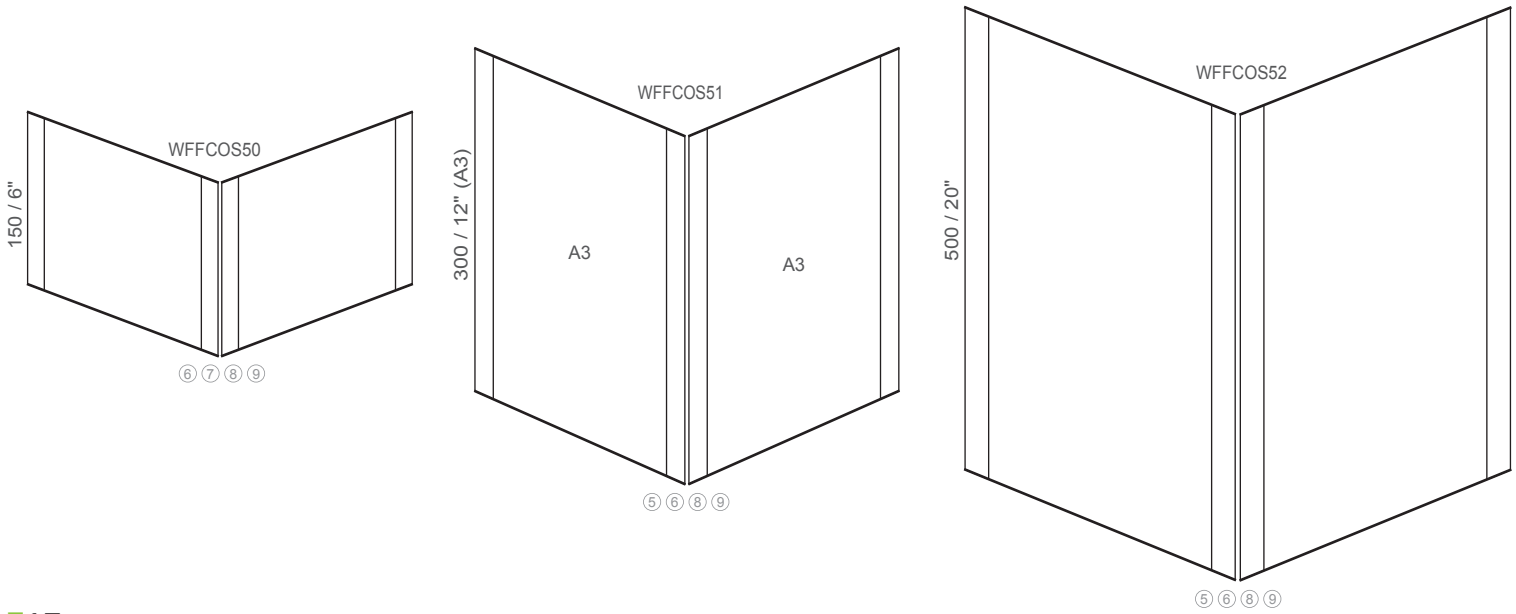
F400



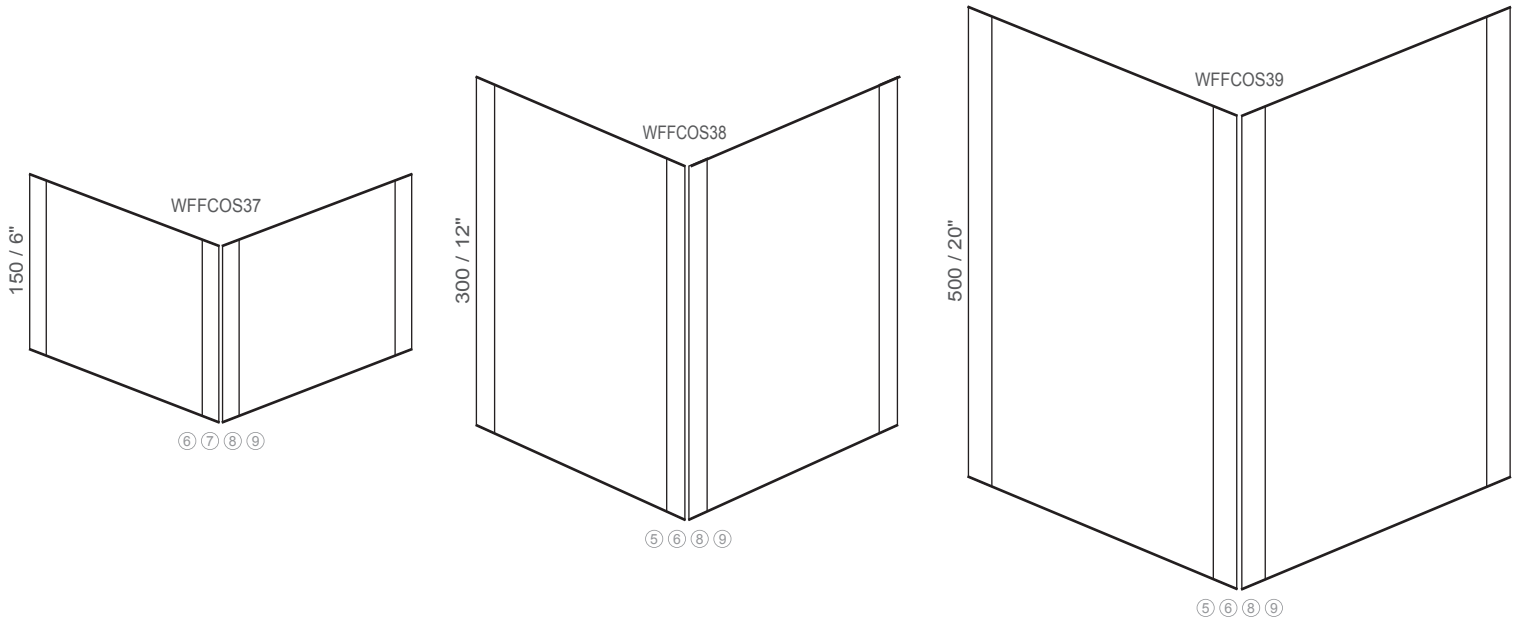
① Please consult the graphic implementation legend on page 2.

Corner signs come only in floating version

F420



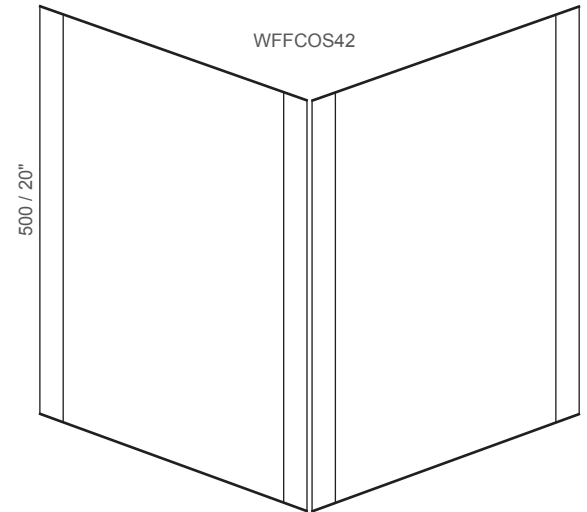
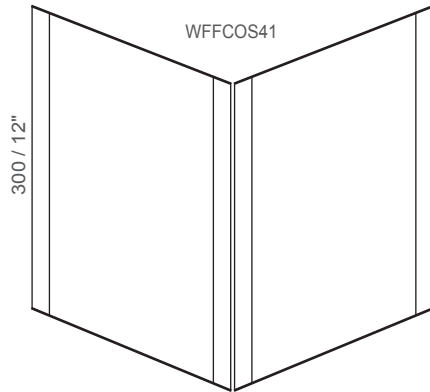
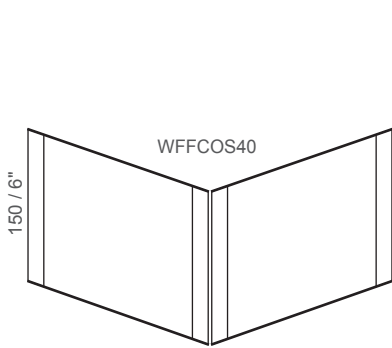
F17



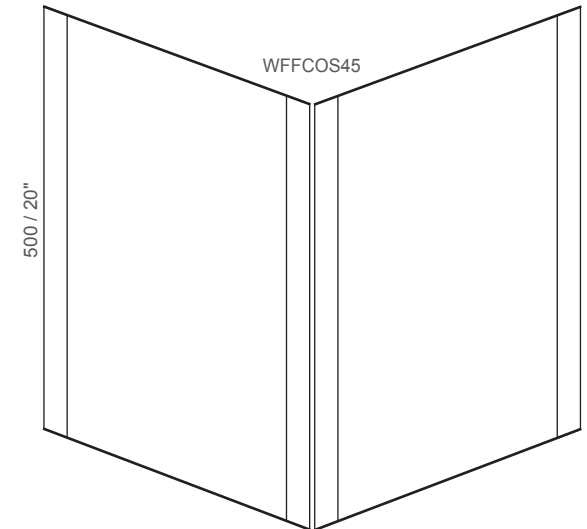
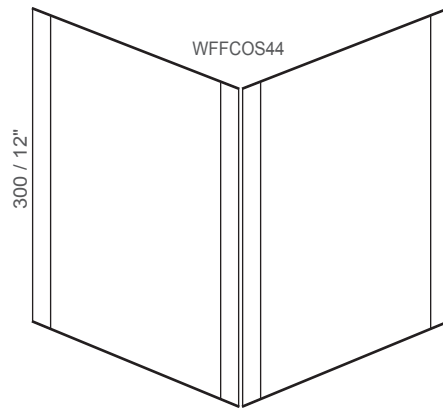
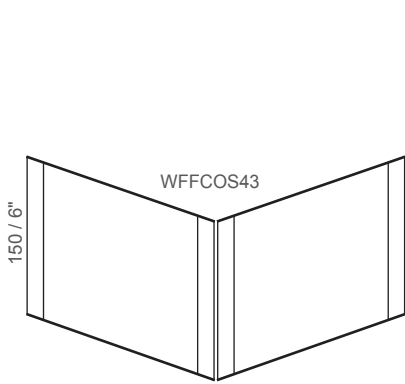
ⓘ Please consult the graphic implementation legend on page 2.

Corner signs come only in floating version

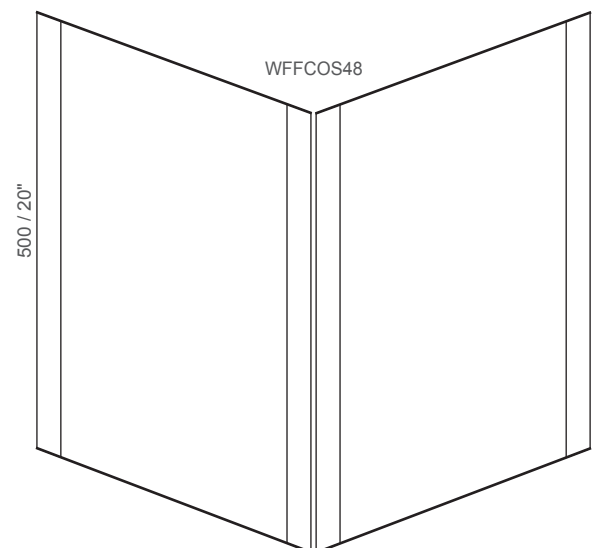
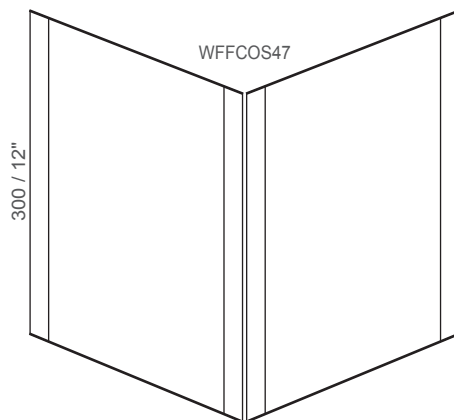
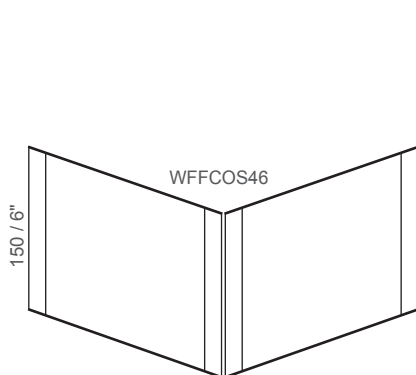
F500 ⑥ ⑦ ⑧ ⑩



F22 ⑥ ⑦ ⑧ ⑩



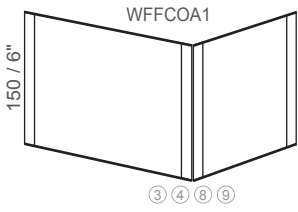
F600 ⑥ ⑦ ⑧ ⑩



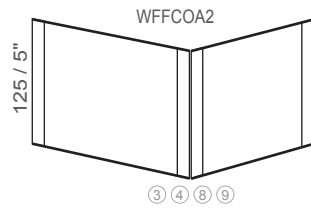
① Please consult the graphic implementation legend on page 2.

Corner signs come only in floating version

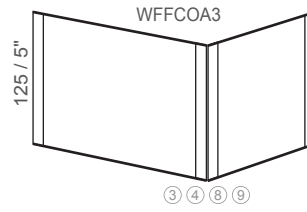
F300+150



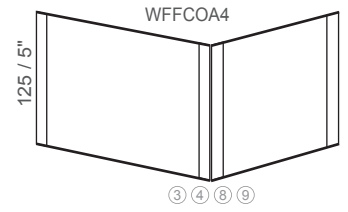
F300+200



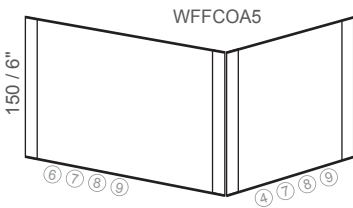
F14+150



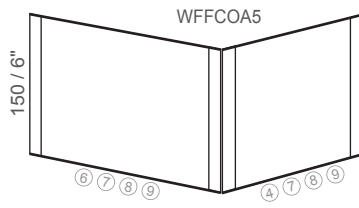
F14+200



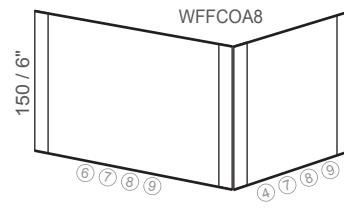
F400+150



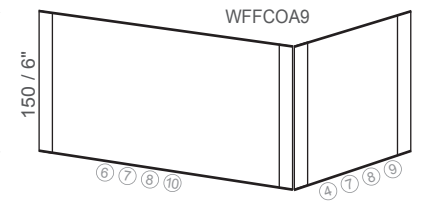
F400+200



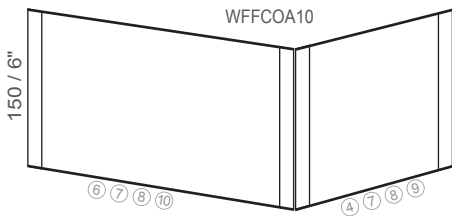
F17+200



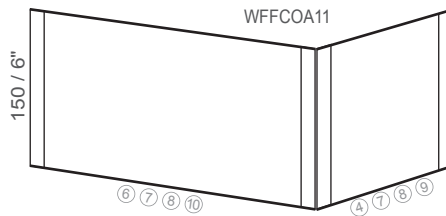
F500+150



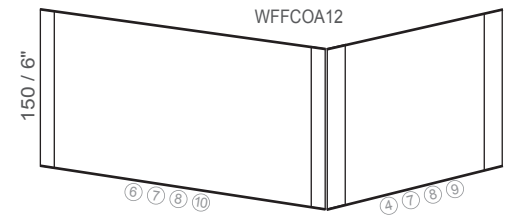
F500+200



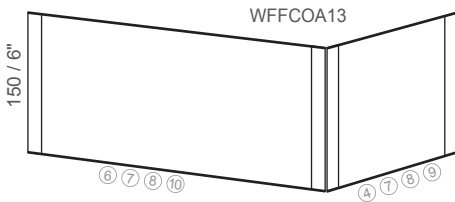
F22+150



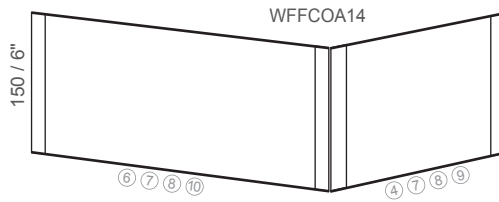
F22+200



F600+150



F600+200

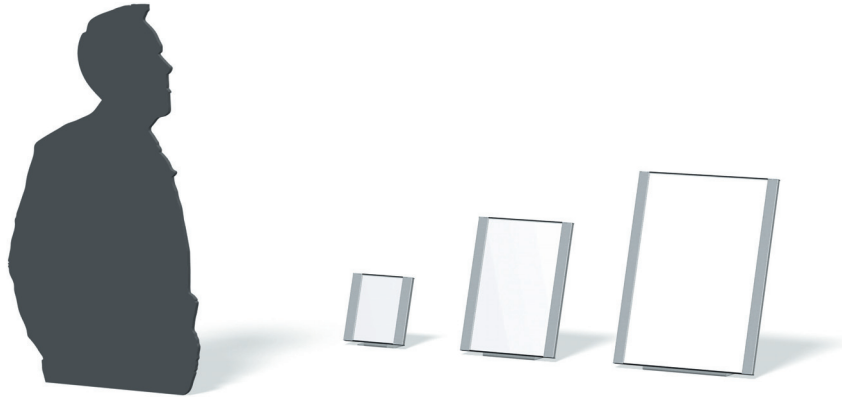


① Please consult the graphic implementation legend on page 2.

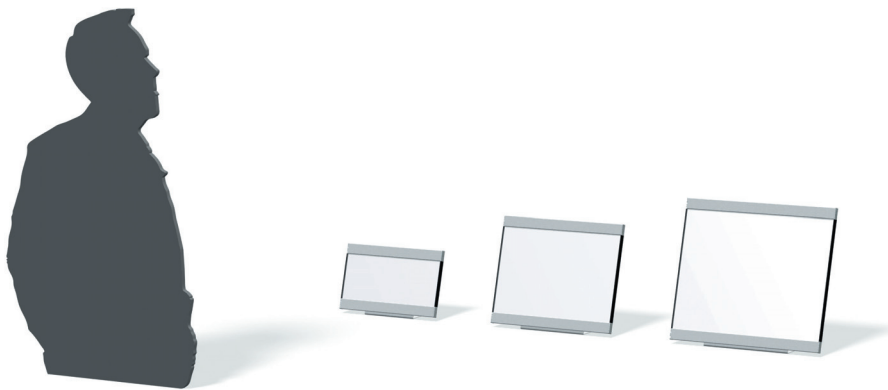


Table signs are most often recognition and promotional signs as opposed to traditional way-finding signs. Such table or counter top signs will be used to introduce the person at the given work station (most often title and name), working hours, special information/instruction and many a times will include a built in brochure or business card holder.

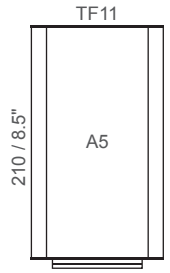
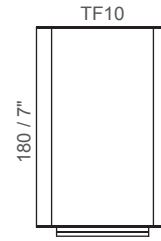
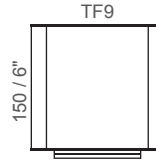
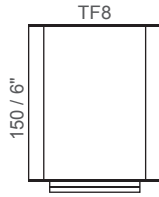
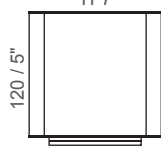
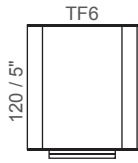
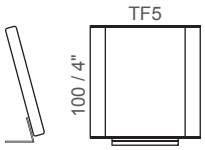
TF-P



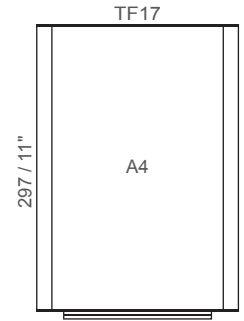
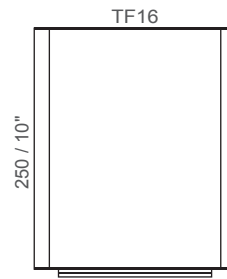
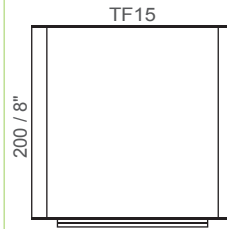
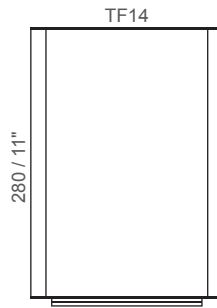
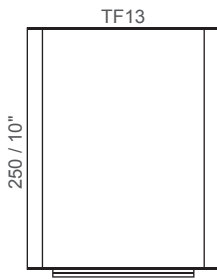
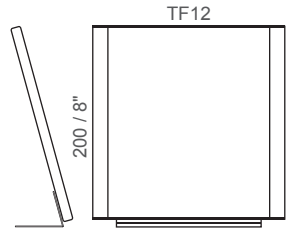
TF-L



F100 ③④⑧⑨

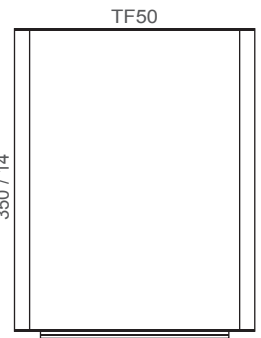
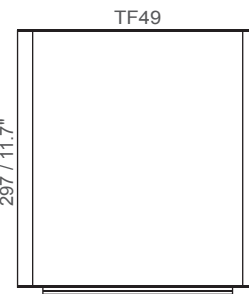
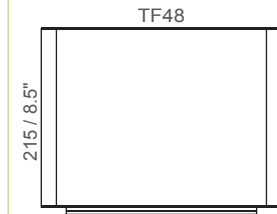
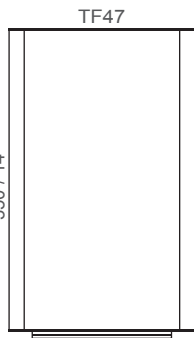
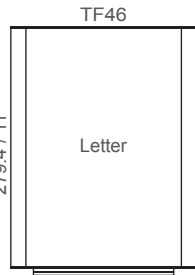
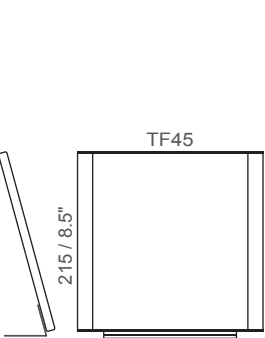


F200 ③④⑧⑨



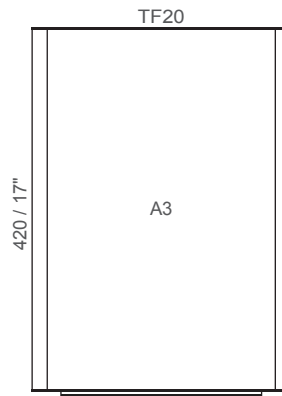
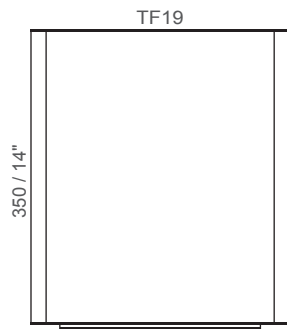
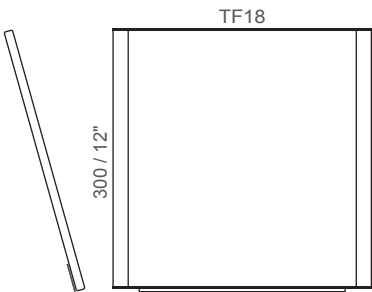
F-A4 ③④⑧⑨

F-Letter ③④⑧⑨



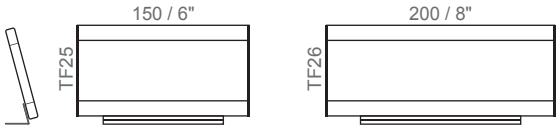
F11 ③④⑧⑨

F300 ③④⑧⑨

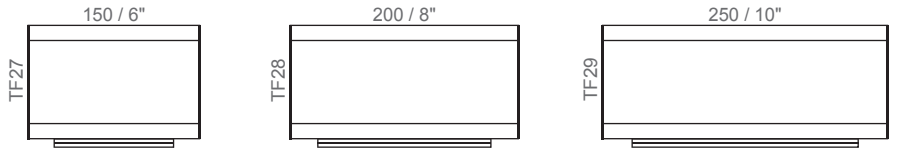


① Please consult the graphic implementation legend on page 2.

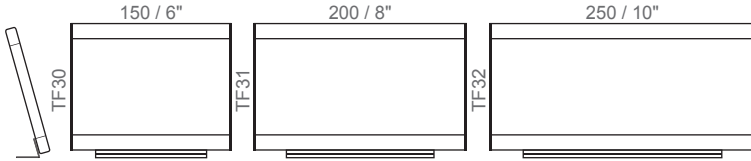
F80 ①②③⑧⑨



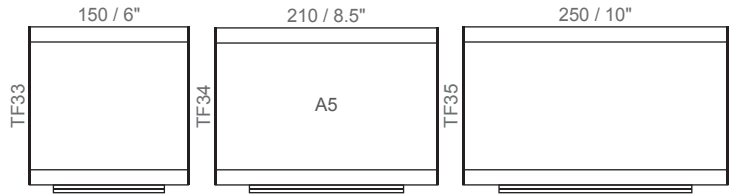
F100 ①②③⑧⑨



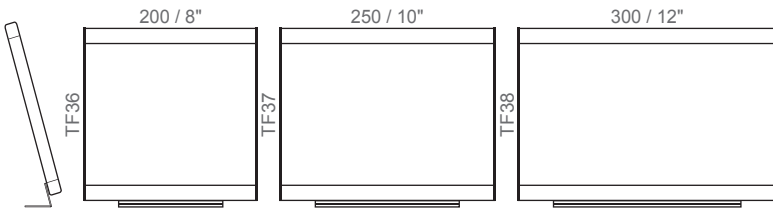
F120 ③④⑧⑨



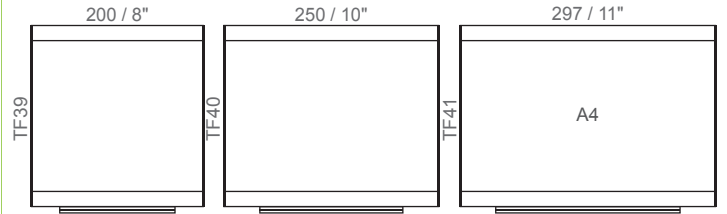
F150 ③④⑧⑨



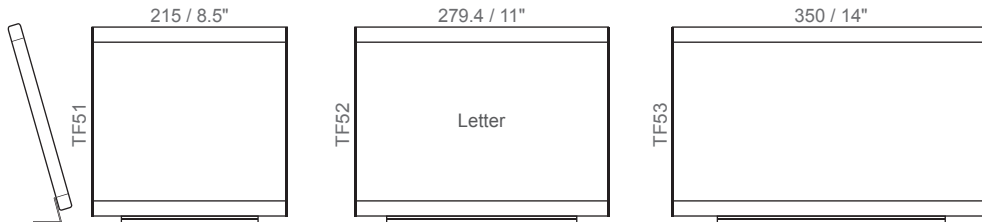
F200 ③④⑧⑨



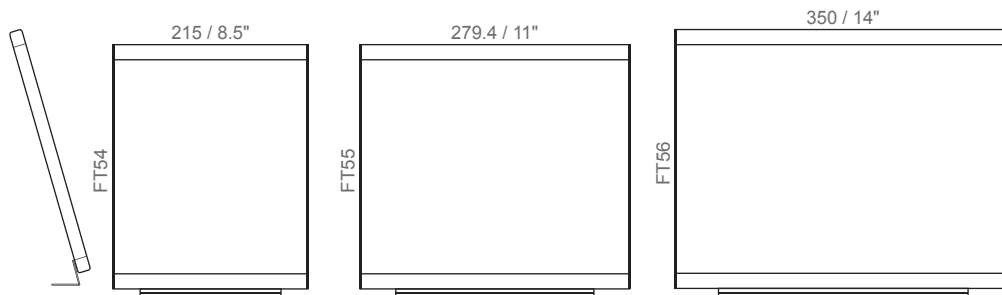
F-A4 ③④⑧⑨



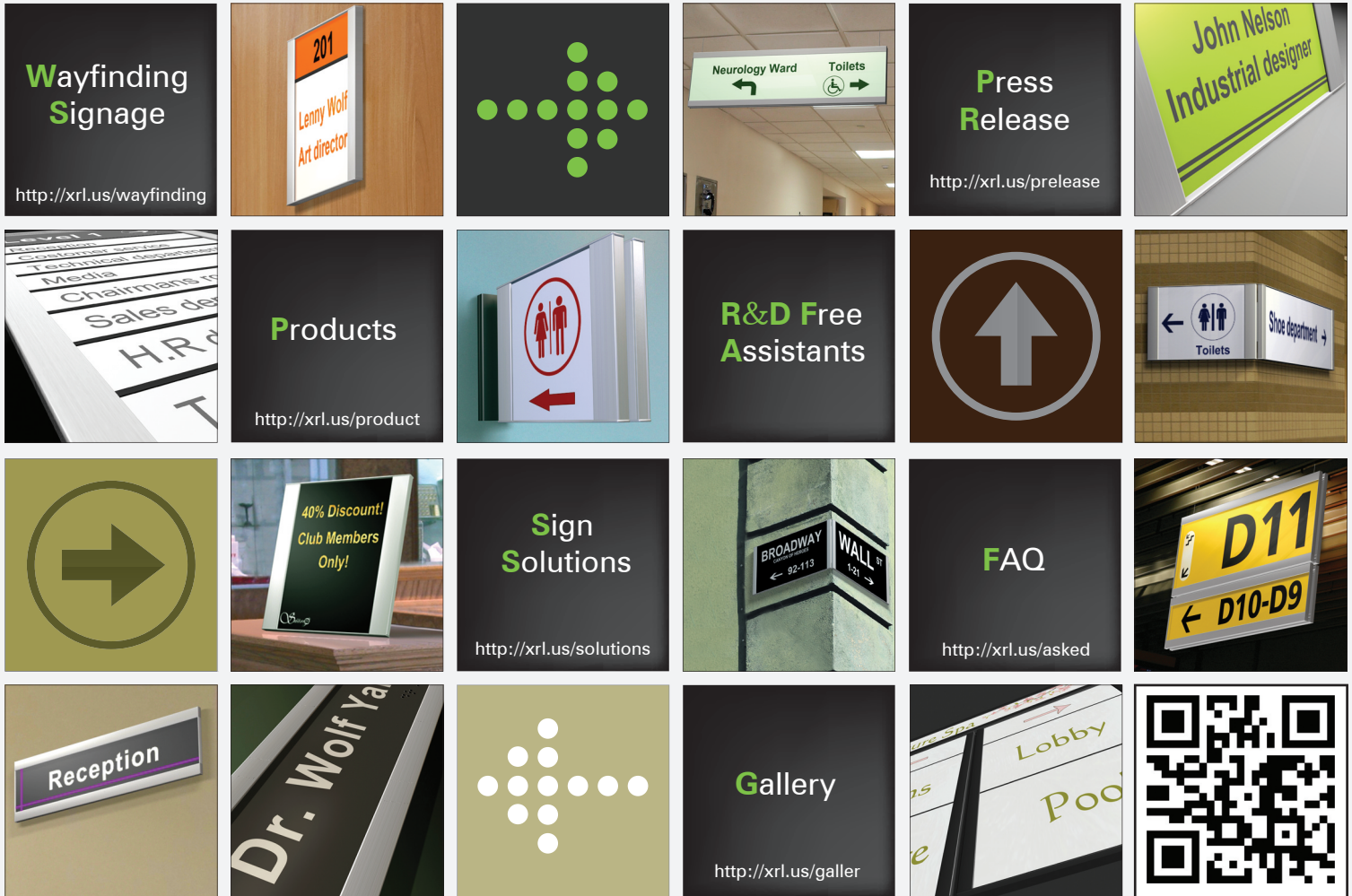
F-letter ③④⑧⑨



F11 ③④⑧⑨



① Please consult the graphic implementation legend on page 2.



GreenSquare offers you a unique selection of prestigious sample kits:

The Travel Kit:



A travel shoulder bag containing a selection of four flat signs including graphics, and the GreenSquare catalog.

This kit can be personalized to present your company name and logo.

The Office Display Kit:



An elegant presentation featuring a wide selection of flat sign samples mounted on a back board; Ideal for reception area, show room or office display.

This kit can be personalized to present your company name and logo.



FLAT MODULAR SIGN SYSTEM

GREEN SQUARE

GreenSquare - Stands out above the rest

www.way-finding.com

1800 N East Ave. Unit 102, Sarasota, FL, 34234 USA

Phone: 800-468-4782 (941-365-4646 Internationally)

Fax: 888-316-5198 (941-955-2681 Internationally)

E-Mail: usa@vistasystem.com

Web: www.vistasystem.com

Proudly Distributed By 